

PetE 216
Petroleum Rock and Fluid Properties
LABORATORY MANUAL

Ankara, 2003

CONTENTS:

1. LABORATORY SAFETY.....	6
1.1. FIVE PRINCIPLES OF SAFETY.....	6
1.1.1. Practice Safety	6
1.1.2. Be Concerned About the Safety of Others.....	6
1.1.3. Understand the Hazards Associated with Your Particular Experiment.....	6
1.1.4. Know what to do in an Emergency.....	6
1.1.5. Report Hazards or Hazardous Conditions.....	7
1.2. FIRST AID.....	8
1.2.1. STOPPAGE OF BREATHING	8
1.2.2. SEVERE BLEEDING	8
1.2.3. THERMAL BURNS.....	8
1.2.4. TRAUMATIC SHOCK.....	8
1.3. SAFETY RULES.....	8
1.3.1. PERSONAL PRECAUTIONS	8
1.3.2. LABORATORY PRACTICE.....	9
1.4. CHEMICAL HAZARDS AND SAFETY PROCEDURES.....	11
1.4.1. UNATTENDED CHEMICAL REACTIONS	11
1.4.2. TOXIC HAZARDS	11
1.4.3. ACIDS AND BASES	11
1.4.4. ORGANIC SOLVENTS.....	12
1.5. CHEMICAL WASTE DISPOSAL.....	12
1.6. RADIATION HAZARDS.....	12
1.6.1. Radioactive Materials	12
1.6.2. X-Rays Equipments	13
1.7. ELECTRICAL HAZARDS AND SAFETY PROCEDURES.....	13
1.7.1. PRECAUTIONS	13
1.7.2. STATIC ELECTRICITY AND SPARK HAZARDS.....	13
1.8. FIRE SAFETY RULES.....	14
1.8.1. PRECAUTIONARY PROCEDURES	14
1.8.2. EMERGENCY PROCEDURES.....	14
1.8.3. ELECTRICAL FIRES	14
2. INTRODUCTION.....	15
3. POROSITY.....	17
3.1. Definitions.....	17
3.2. Effect of Compaction on Porosity.....	17
3.3. Porosity Measurements.....	18
3.3.1. Bulk Volume Measurement	18
3.3.2. Pore Volume Measurement.....	19
3.3.3. Grain Volume Measurement.....	20
4. PERMEABILITY.....	21
4.1. Definition.....	21
4.2. Darcy's Law.....	21
4.3. Kozeny-Carman Model.....	21
4.4. Klinkenberg Effect.....	23
4.4.1. Ideal Gas Flow.....	24
4.4.2. High Velocity Flow	25

5. CAPILLARY PRESSURE.....	26
5.1. <i>Definitions</i>	26
5.2. <i>Capillary Pressure Measurement Methods</i>	28
5.2.1. Porous Plate Method (restored state)	28
5.2.2. Centrifuge Method.....	28
5.2.3. Mercury injection (Purcell - 1949) Method	32
5.2.4. Dynamic Method	32
5.2.5. Comparison of Methods	33
5.3. <i>Converting Laboratory Data</i>	34
5.4. <i>Pore-size distribution</i>	35
5.4.1. Pore Size Distribution of Reservoir Rocks Burdine et al. [1950]	35
6. SURFACE AND INTERFACIAL TENSION.....	37
6.1. <i>Definition</i>	37
6.2. <i>Methods of Interfacial Tension Measurements</i>	38
6.2.1. Capillary Rise Method.....	38
6.2.2. Wilhelmy Plate Method.....	38
6.2.3. Ring Method	39
6.2.4. Drop Weight Method.....	40
6.2.5. Pendant Drop Method.....	41
6.2.6. Spinning Drop	42
7. LIQUID DENSITY	43
7.1. <i>Definitions</i>	43
7.2. <i>Measurement of density</i>	43
8. VISCOSITY	45
8.1. <i>Definitions</i>	45
8.2. <i>Effect of pressure and temperature on viscosity</i>	46
8.3. <i>Methods for Measuring Viscosity</i>	46
8.3.1. Capillary Type Viscometer.....	46
8.3.2. Falling Ball Viscometer.....	47
8.3.3. Rotational Viscometer	48
9. VAPOR PRESSURE OF A PURE LIQUID	50
9.1. <i>Definitions</i>	50
9.2. <i>Theory</i>	50
10. EXPERIMENTS	52
10.1. <i>Effective Porosity Determination by Gas Expansion Method</i> (Experiment 1).....	52
10.1.1. Description	52
10.1.2. Experimental set-up	52
10.1.3. Operation of Instrument.....	53
10.1.4. Calculations	54
10.2. <i>Gas Permeability of Unconsolidated Sandpacks and the Effect of Gas Slippage (Experiment 2)</i>	56
10.2.1. Test Procedure	56
10.3. <i>Determination of Porosity and Pore Size Distribution by Mercury Injection (Experiment 3)</i>	57
10.3.1. Description	57
10.3.2. Experimental Set-Up	57
10.3.3. Procedure	57
10.3.4. Calculations	58

10.4.	<i>Determination of the Liquid Permeability of Consolidated Cores (Experiment 4)</i>	60
10.4.1.	Description:.....	60
10.4.2.	Purpose:	60
10.4.3.	Experimental set-up:	60
10.4.4.	Procedure:	61
10.4.5.	Calculations:	63
10.5.	<i>Measurement of Surface Tension & IFT with the Ring Tensiometer (Experiment 5)</i>	66
10.5.1.	Description:.....	66
10.5.2.	Definition:.....	66
10.5.3.	Experimental set-up:	66
10.5.4.	Procedure:	66
10.5.5.	Conclusion:	67
10.6.	<i>Fluid density using the Pycnometer Method and Hydrometer Method (Experiment 6)</i>	69
10.6.1.	Description.....	69
10.6.2.	Purpose	69
10.6.3.	Experimental set-up:	69
10.6.4.	Calculations	70
10.7.	<i>Liquid Viscosity Measurement Using Capillary Tube Viscometer, Cone and Plate Type Viscometer, Saybolt Viscometer (Experiment 7a, 7b, 7c)</i>	72
10.7.1.	Experiment 7a - Ostwald Type Viscometer	72
10.7.2.	Procedure	72
10.7.3.	Calculations	72
10.7.4.	Experiment 7b - Dynamic Viscosity by Cone and Plate Viscometer.....	72
10.7.5.	Experiment 7C - Viscosity Measurement by Saybolt Viscometer	73
10.8.	<i>Vapor Pressure of a Pure Liquid (Experiment 8)</i>	75
10.8.1.	Description.....	75
10.8.2.	Experimental Equipment and Procedure.....	75
10.8.3.	Calculations	75
11.	LABORATORY REPORT FORMAT.....	77
12.	APPENDIX	78

LIST OF FIGURES:

Figure 2.1 Data obtained from cored wells	16
Figure 3.1 a) Cubic packing, b) rhombohedral packing, c) cubic packing with two grain sizes and d) typical sand with irregular grain shapes	18
Figure 3.2 Schematic diagram of a) helium porosimeter apparatus and b) The helium porosimeter.	20
Figure 3.3 a) Mercury injection pump and b) porosity through mercury injection.....	20
Figure 4.1 Variation in gas permeability with mean pressure and type of gas [Klinkenberg, 1941]	23
Figure 4.2 Linear flow of an ideal gas in sand-filled tube.....	24
Figure 5.1 Typical capillary pressure curve.	27
Figure 5.2 The porous plate method assembly.	28
Figure 5.3 Schematic diagram of a core in a centrifuge and its boundary conditions.....	29
Figure 5.4 a) Graphical differentiation of $SP_{cL} - P_{cL}$ curve to determine b) $S - P_{cL}$ curve.	31
Figure 5.5 Apparatus for mercury injection method.	32
Figure 5.6 Dynamic capillary pressure apparatus.	33
Figure 5.7 Mercury capillary pressure curve Burdine et al. [1950]	36
Figure 6.1 Capillary equilibrium of a spherical cap.	37
Figure 6.2 Capillary-rise method.....	38
Figure 6.3 Wilhelmy plate methods; Dynamic (a) and static method (b).	39
Figure 6.4 Ring method	40
Figure 6.5 Hanging drop from a capillary tube.	40
Figure 6.6 Relationship between dimensions of a pendant drop.....	41
Figure 6.7 Schematic diagram of a spinning drop.....	41
Figure 7.1 Schematic diagrams of the hydrometer (a), pycnometer (b), and bicapillary pycnometer (c).	44
Figure 8.1 Steady-state velocity profile of a fluid entrained between two flat surfaces.	45
Figure 8.2 Shear stress vs. shear rate for a Newtonian fluid.	45
Figure 8.3 Two types of Ostwald viscometers.	46
Figure 8.4 Schematic diagram of the falling ball viscometer.....	48
Figure 8.5 Schematic diagram of the rotational viscometer.....	48
Figure 10.1 Resistivity Injection System.....	64

1. LABORATORY SAFETY

1.1. FIVE PRINCIPLES OF SAFETY

Our Safety Program incorporates only a few principles, but each one is essential. These principles are:

1. Practice safety
2. Be concerned about the safety of others
3. Understand the hazards associated with your particular experiment
4. Know what to do in an emergency
5. Report hazards or hazardous conditions

1.1.1. Practice Safety

One problem concerning the practice of safety is that it is a subjective matter. In order to have an effective safety program, some common basic rules must be established. This is the main purpose of this Safety Manual. Some of the more basic safety practices that you are expected to follow are:

- a) Wear appropriate eye protection whenever working with any potential eye hazards.
- b) Use a hood for hazardous, volatile, and noxious chemicals.
- c) Label an experiment to show its associated dangers and the persons to contact in case of a danger.
- d) You are further expected to secure all gas cylinders, to label all containers, to observe posted signs, such as no smoking, and so on.

1.1.2. Be Concerned About the Safety of Others

Your concern for safety must include the people around you. Your experiment must be safely maintained so that everyone in the area is amply protected and warned of inherent dangers. In addition, this principle of looking out for the other person should include the practice of pointing out unsafe procedures to those people committing the unsafe act. Another aspect of this second principle involves alerting those around you in case of an accident. It is your responsibility to alert personnel in the immediate vicinity of a fire or an emergency!

1.1.3. Understand the Hazards Associated with Your Particular Experiment

Prevention is the key to safety. Prior to designing any experiment, using a new piece of equipment, or handling the chemicals in the laboratory, it is wise to consider the potential hazards and safety precautions involved in the work. Hazards may include toxic substances, electrical circuits, mechanical equipment and waste chemicals. Safety precautions should include correct materials storage, proper ventilation, proper grounding of equipment and training sessions when necessary. Material Safety Data Sheets (MSDS) and equipment manuals are important sources of information.

1.1.4. Know what to do in an Emergency

You must be prepared to respond quickly and precisely to an emergency. You must familiarize yourself with the laboratory you are working in, its exits, and its associated safety equipment: eyewash stations, showers, sinks, fire blankets, fire extinguishers, and spill kits. Just a few moments spent learning the locations and use of these pieces of equipment prior to an emergency could save a life.

If the emergency is of an infiltrating nature, such as a fire, gas leak, release of toxic fumes, or radiation leak, the following procedures should be followed:

- **Alert personnel in the immediate vicinity**
- **Confine the fire or emergency, if possible**
- **Summon aid**
- **Evacuate the building**
- **Report pertinent information to responding emergency personnel.**

It is worth commenting on each of these procedures.

Alert personnel in the immediate vicinity: When alerting the personnel in the vicinity of a fire or emergency, assign several of them the responsibility of assisting in the remaining procedures. Especially assign someone the task of summoning aid!

Confine the fire or emergency, if possible: Confining fires or other emergencies means taking measures to prevent them from spreading. In case of fire, close doors and windows securely. If the fire is not threatening you, use an appropriate fire extinguisher. Do not waste valuable time trying to confine an emergency when it is beyond your control. Follow evacuation procedures.

Summon aid: The Fire Department, The Police Department, and Medical Services can be contacted. When summoning aid, telephone from a safe location. You should be prepared to state precisely the location and the nature of the emergency. Do not hang up until you have given all of the pertinent information.

Evacuate the building: Evacuating the building means sounding the fire alarm system and going to the nearest exit.

Report pertinent information to responding emergency personnel: Meet, or designate someone to meet, responding emergency personnel at a specific location and report pertinent information.

If the emergency does not necessitate a confinement or evacuation procedure, such as an individual being injured, you must still be prepared to alert nearby personnel and summon aid. You may also have to administer some emergency treatment yourself.

1.1.5. Report Hazards or Hazardous Conditions

You must report any incident to the Environmental Health and Safety Office without delay.

The remainder of this Safety Manual presents examples of hazards that you are likely to encounter in the laboratory and what you should know about them to minimize their danger to you and to others.

1.2. FIRST AID

There are certain serious injuries in which time is so important that treatment must be started immediately.

1.2.1. STOPPAGE OF BREATHING

For stoppage of breathing (e.g. from electrical shock or asphyxiation), the mouth-to-mouth method of resuscitation is far superior to any other known. If victim is found unconscious on the floor and not breathing, rescue breathing must be started at once, seconds count.

1.2.2. SEVERE BLEEDING

Severe bleeding can almost always be controlled by firm and direct pressure on the wound with a pad or cloth. The cleaner the cloth, the more desirable it is; however, in an emergency, use part of the clothing. In addition:

1. Wrap the injured to avoid shock and call immediately for medical attention.
2. Raise the bleeding part higher than the rest of the body and continue to apply direct pressure.
3. Keep victim lying down.
4. Never use a tourniquet.

1.2.3. THERMAL BURNS

1. If the burn is minor, apply ice or cold water.
2. In case of clothing fire:
 - a. The victim should drop to the floor and roll, not run to a safety shower. A fire blanket, if nearby, should be used to smother the flames.
 - b. After flames are extinguished, deluge the injured under a safety shower, removing any clothing contaminated with chemicals.
 - c. Keep the water running on the burn for several minutes to remove heat and wash area.
 - d. Place clean, soaking wet, ice-packed cloth on burned areas.
 - e. Never use a fire extinguisher on a person with burning clothing.

1.2.4. TRAUMATIC SHOCK

In cases of traumatic shock, or where the nature of the injury is not clear, keep the victim warm, lying down and quiet. Wait until medical assistance arrives before moving the victim. One should treat all injuries as potential shock situations, as they may turn into one. Some common symptoms of shock are cold and clammy skin, paleness, and delirium.

1.3. SAFETY RULES

1.3.1. PERSONAL PRECAUTIONS

1. **Avoid working alone in the laboratory:** An individual is advised to work only under conditions in which appropriate emergency aid is available when needed. If others are working nearby, let know where you will be working so that they can occasionally check on you and you can check on them.
2. **Eye protection:** In order to work safely, you must certainly protect your eyes. This can be achieved by wearing safety glasses or mask.

3. **Ear protection:** Long term exposure to high sound levels will produce a permanent hearing loss. There appears to be no hearing hazard to sound exposure below 80 dB. Exposure above 130 dB is hazardous and should be avoided by wearing ear plugs.
4. **Usage of mask:** Suitable masks should be used in case of breathing in hazardous materials. Some masks protect from dust only. Masks with cartridges should be used for toxic gases.
5. **Clothing:** Wearing lab coats is necessary. Shorts and open-toed shoes are not recommended when working in the lab. Never wear loose clothing in the lab.
6. **Hand protection:** For any laboratory procedure requiring the use of clothes, make sure you are using gloves made of a material suitable for the operation.
7. **Food and beverages:** Consumption of food and beverages in the labs is not permitted.
8. **Personal hygiene:** Wash hands and arms prior to leaving the laboratory.

1.3.2. LABORATORY PRACTICE

A. HAZARDOUS CHEMICALS

1. All containers must be labeled.
2. Do not use chemical from unlabeled containers.
3. Never taste or smell any chemical.
4. Clean spills immediately.
5. Avoid direct contact with any chemical. What might be considered safe today may eventually be found to be harmful.

B. MERCURY SPILLS

For small spills or well contained spills, gather mercury and put it in a closed container (wear gloves). Petroleum and Natural Gas has a special filtered mercury vacuum for picking up larger spills. Never use a regular vacuum, the mercury will contaminate the vacuum and release large quantities of Hg vapor.

C. GLASSWARE

1. Use only Pyrex or shutter proof glassware.
2. Never use cracked or chipped glassware.
3. Insert tubing properly into stoppers.

D. EQUIPMENT

1. Before using an instrument of machine, be sure you have been instructed and authorized by the person responsible for the equipment.
2. Become familiar with potential hazards associated with the equipment, emergency shut down procedures, as well as the operating procedures.
3. Check all electrical connections and check that all rotating parts are free to turn.
4. Attach an "emergency shutdown card" to any piece of equipment left operating unattended outside normal working hours.
5. Laboratory equipment should not be placed in corridors.

a. Gas Cylinders

1. Secure gas cylinders with a strap or chain to a stable object. Transport gas cylinders, with the cap security in place, and always use the proper cart.
2. Do not use an open flame near gas cylinders.
3. Before using gas in an experiment, be sure there are no leaks in the system.
4. Never use grease or other lubricants on gauges or connections.
5. Learn directions for closing and opening valves.
6. Only use regulators, pipes and fitting specified for the type of gas you will be using.
7. Do not locate gas cylinders near heat sources, like furnaces.
8. Familiarize yourself with the toxic properties of each gas you work with. Post any safety information that may pertain to others working in the lab.
9. Store oxygen cylinders and combustible gases separately

b. Vacuum Systems

Mechanical vacuum pumps in laboratories pose common hazards. These are the mechanical hazards associated with any moving parts and the chemical hazards of contaminating the pump oil with volatile substances.

Distillation or concentration operations requiring large concentrations of volatile substances should be performed using a water aspirator. The output of the pumps should be vented to a hood or alternate exhaust system. The pump oil should also be replaced when it becomes contaminated and disposed.

1. Be certain that your vacuum system has a trap.
2. Use only containers that can withstand evacuation.
3. Always close the valve between the vacuum vessel and the pump before shutting off the pump to avoid sucking vacuum oil into the system.
4. All moving belts on mechanical pumps must have a safety cover.

c. Distillation and Condensers

Superheating and sudden boiling frequently occur when distilling under vacuum. Therefore it is important that the assembly be secured and the heat be distributed evenly. An additional thermometer should be inserted near the bottom of the distilling flask to warn of a dangerous exothermic reaction. After finishing a vacuum distillation, cool the system before slowly bleeding in air, since air may induce an explosion in a hot system.

d. Drying Ovens

Electric ovens are often used in the laboratories for removing solvents or water from samples and to drive laboratory glassware. These ovens if not properly vented or used in a hood, discharge the volatile substances into the laboratory atmosphere which can accumulate in toxic concentrations. Small amounts of vapor can accumulate inside the oven and mix with the air to form explosive mixtures.

Ovens should not be used to dry any chemical to possess toxic vapors or that might volatilize and pose an explosion hazard or acute chemical hazard unless special precautions had been taken to ensure continuous venting to a hood. It is recommended to have blow out panels in the rear of a drying oven so that an explosion will not blow the door and contents into the laboratory.

E. TRANSPORTING CHEMICALS

When chemicals are carried by hand, they should be placed in a carrying container or acid-carrying bucket to protect against breakage and spillage. Chemicals should not be carried in open containers in hallways or elevators where they may be spilled.

F. CHEMICAL STORAGE

Every chemical should have a specific storage space. They should not be stored on counter tops where they can be knocked over or in hoods where they interfere with proper air flow. Flammable liquids should be stored in ventilated storage cabinets. Flammable liquids should not be stored near ignition sources or in areas where accidental contact with strong oxidizing agents is possible.

Oxidizing agents include: chromic acid, permanganates, chlorates, per-chlorates, and peroxides. All chemicals must be properly labeled giving the chemical name, name of owner, date of purchase, type of hazard and any emergency procedures.

1.4. CHEMICAL HAZARDS AND SAFETY PROCEDURES

The first step in using any chemical should be a review of the material safety data sheet supplied by the manufacturer, available from the section's technician.

1.4.1. UNATTENDED CHEMICAL REACTIONS

Take great care in setting up chemical reactions that are to be left unattended for any period of time. Note that unattended operation should be avoided if at all possible. The possible hazards that might arise from failure of a heating mantle, failure of a water cooling system, and failure of an exhaust, are obvious points to check before leaving a reaction unattended. The experimenter should also notify his/her advisor that the experiment will be running overnight.

1.4.2. TOXIC HAZARDS

Researchers should be aware of the toxic hazards of the materials they are using, and those being used by others their vicinity. Care should be taken to prevent toxic materials that may enter the body through the skin, inhalation or ingestion. A large number of common substances are acute respiratory hazards and should be used only in a hood.

Some toxic substances are: ammonium hydroxide, carbon monoxide, chlorine, fluorine, hydrochloric acid, hydrogen sulfide, and sulfur dioxide...

1.4.3. ACIDS AND BASES

Acids and bases are found in most laboratories since there are a variety of applications for them. Three important hazards are:

1. Chemical burns suffer from spills
2. Inhalation of caustic vapor
3. Fires or explosions caused by strongly exothermic reactions occurring when strong acid are diluted rapidly.

Strong bases may often cause more severe burns than acids. Therefore strong bases should be carefully handled.

1. Always dilute acids by adding them to water and not vice versa.
2. Use dilute acids and bases whenever possible.
3. Keep bottles of strong acids and bases closed when not in use.
4. If acids or bases are accidentally splashed in the eye or on the skin, flush with water immediately, continue flushing for 15 minutes, call for help.

1.4.4. ORGANIC SOLVENTS

Many organic solvents possess harmful vapors for human health. These organic solvents are also volatile and the vapors are flammable. One should be aware of the hazards, and safety precautions while using these solvents.

Acetone: Possesses toxic and flammable vapors. Use proper ventilation, safety glasses and gloves

Methanol: Possesses harmful vapors that can cause dizziness, central nervous system depression and shortness of breath. So it should be used in a ventilated hood and neoprene gloves should be worn.

Benzene: Carcinogenic. Chronic poisoning can occur by inhalation of relatively small amounts over a long time. It can also be absorbed through the skin. Vapors are flammable and it should be stored carefully.

1.5. CHEMICAL WASTE DISPOSAL

Each individual has the responsibility for seeing that laboratory waste chemicals are safely collected, identified, stored for disposal, and that anyone involved is fully advised of the need for any special methods or facilities for proper disposal. Disposal of chemical waste down the drain to the sanitary sewer systems is hazardous. Material flushed to the sewer can be dangerous to maintenance personnel and the public. Chemical vapors and odors can recirculate back into the buildings.

When collecting compatible solvents in the same container do not mix halogenated and non-halogenated solvents. The container must have all the ingredients and concentrations listed on the outside.

1.6. RADIATION HAZARDS

Radiation hazards arise when using radio-isotopes, lasers, x-ray generators and plasma torches. Each is a hazardous in a unique way. A thorough knowledge of the device or the isotope which is to be used is mandatory.

1.6.1. Radioactive Materials

1. All persons working with radioactive materials or equipments must obtain dosimeters from the Health Physics Office and complete the training session before beginning their work.
2. Do not wear other's dosimeter or allow another person to wear yours.
3. A dosimeter should be changed every three months.
4. Clearly mark areas in which lasers, ultraviolet, or high intensity light sources are in use.
5. Wear eye protection appropriate to the type of radiation being used when working with these sources.
6. Remember that electron microscopes are x-ray sources.
- 7.

1.6.2. X-Rays Equipments

1. Under no circumstance should any part of the body be placed directly in primary x-ray beams.
2. Whenever possible turn the x-ray beam off before working on the machine.
3. Do not use any x-ray machine that is not working properly.
4. Wear any required personnel monitoring devices at all times while using x-ray machine.
5. Remember the additional high voltage hazards associated with x-rays machines.

1.7. ELECTRICAL HAZARDS AND SAFETY PROCEDURES

While electricity is in constant use by the researcher, both within and outside the laboratory, significant physical harm or death may result from its misuse. With direct current, a man can detect a “tingling” feeling at 1 mA and the median “let-go” threshold (the current at which he cannot release the conductor) is 76 mA. For 60 Hertz alternating current, the values are 0.4 mA and 16 mA, respectively. Women are more sensitive to the effect of electrical current. Higher currents produce respiratory inhibition, then ventricular fibrillation, and ultimately cardiac arrest. If an electrical hazard is suspected, the device in question should be disconnected immediately and the cause ascertained by a person competent in such matters.

1.7.1. PRECAUTIONS

Multi-strip outlets should not be used in place of permanently installed receptacles. If additional outlets are required have them installed by an electrician.

1. Turn off the power to equipment before inspecting it. Turn off circuit breakers or unplug the equipment.
2. Use only tools and equipment with non-conducting handles when working with electrical devices.
3. When checking an operating circuit keep one hand either in a pocket or behind back to get the extra style points from the Russian judge (to avoid making a closed circuit through the body).
4. Never change wiring with circuit plugged into power source.
5. Avoid contacting circuits with wet hands.
6. Check circuits for proper grounding with respect to the power source.
7. Keep the use of extension cords to a minimum and cords as short as possible.
8. Do not use or store highly flammable solvents near electrical equipment.
9. Maintain a work space clear of extraneous material such as books, papers, and clothes.
10. Do not insert another fuse of larger capacity if an instrument keeps blowing fuses - this is a symptom requiring expert repairs. If a fuse blows, find the cause of the problem before putting in another one.

1.7.2. STATIC ELECTRICITY AND SPARK HAZARDS

Sparks may result in explosion in areas where flammable liquids are being used and therefore proper grounding of equipment and containers is necessary.

Some common potential sources of spark are:

1. The making and breaking of an electrical circuit when the circuit is energized
2. Metal tanks and containers
3. Plastic lab aprons
4. Metal clamps, nipples, or wire used with non-conducting hoses
5. High pressure gas cylinders upon discharge

1.8. FIRE SAFETY RULES

1.8.1. PRECAUTIONARY PROCEDURES

1. Know the location of fire exits, fire alarms, fire blankets and extinguishers.
2. Keep all fire doors closed at all times.
3. Do not block access to fire escape routes.
4. Neatness prevents many fires. Fire spreads much faster when it has cluttered waste materials to feed on. Oil rags, waste or papers improperly stored are common causes of spontaneous combustion. Store these materials in covered metal containers. Overloaded electrical circuits are potential fire hazards. Flammable vapors can ignite far away from their source and thus should be vented properly.

1.8.2. EMERGENCY PROCEDURES

1. If a fire starts, activate the nearest fire alarm box then call for assistance from a safe location. If the fire is not too large, confine and try to extinguish it with the proper type of extinguishers in the lab. Never jeopardize your personal safety in trying to extinguish a fire.
2. If there is no injury, and the fire is contained in a vessel, it can usually be suffocated by covering the vessel with a non-flammable object. Do not use towels or clothes. Remove nearby flammable materials to avoid possible spread of fire. If the fire is over an area too large to be suffocated quickly and simply, abandon the fire.
3. If evacuation is necessary, and if time allows, shut off power to any equipment. Shut off gas or other open flames. Turn off hot plates and main gas valves.
4. If your clothes ignite, “stop, drop and roll” to smother the flames. Do not run, running only intensifies the flames. When the fire blankets are readily available, use them to wrap around yourself. Call for help.
5. Exit from the building via staircases; do not take elevators. Remove any objects that may be obstacles in passageways or to the fire doors. Do not return to the building unless the fire is under control.

1.8.3. ELECTRICAL FIRES

1. Turn off power source at the breakers or the junction box and unplug.
2. Use CO₂ or dry chemical extinguisher to put out fire. Never use water.
3. When fire extinguished check circuit to determine cause.
4. Do not turn on circuit until cause of fire has been established and the fault corrected.

2. INTRODUCTION

Knowledge of petrophysical and hydrodynamic properties of reservoir rocks are of fundamental importance to the petroleum engineer. These data are obtained from two major sources: core analysis and well logging. In this book some details about the analysis of cores are presented and the nature and quality of the information that can be deduced from cores are reviewed.

Cores are obtained during the drilling of a well by replacing the drill bit with a diamond core bit and a core barrel. The core barrel is basically a hollow pipe receiving the continuous rock cylinder, and the rock is inside the core barrel when brought to surface. Continuous mechanical coring is a costly procedure due to:

- The drill string must be pulled out of the hole to replace the normal bit by core bit and core barrel.
- The coring operation itself is slow.
- The recovery of rocks drilled is not complete.
- A single core is usually not more than 27 m long, so extra trips out of hole are required.

Coring should therefore be programmed in detail, especially in production wells. In an exploration well the coring cannot always be accurately planned due to lack of knowledge about the rock. Now and then if it is a need for samples in an already drilled interval, and then sidewall coring can be applied. In sidewall coring a wire line-conveyed core gun is used, where a hollow cylindrical “bullet” is fired into the wall of the hole. These plugs are small and usually not very valuable for reservoir engineers.

During drilling the core becomes contaminated with drilling mud filtrate and the reduction of pressure and temperature while bringing the core to surface results in gas dissolution and further expulsion of fluids. The fluid content of the core observed on the surface cannot be used as quantitative measure of saturations of oil, gas and water in the reservoir. However, if water based mud is used the presence of oil in the core indicates that the rock formation is oil bearing.

When the core arrives in the laboratory plugs are usually drilled 20-30 cm apart throughout the reservoir interval. All these plugs are analyzed with respect to porosity, permeability, saturation and lithology. This analysis is usually called routine core analysis. The results from routine core analysis are used in interpretation and evaluation of the reservoir. Examples are prediction of gas, oil and water production, definition of fluid contacts and volumes in place, definition of completion intervals etc. Data from routine core analysis and from supplementary tests and the application of these data are summarized in Figure 1.1.

Special core analysis includes several measurements with the objective of obtaining detailed information about multiphase flow behavior. Special core analysis gives information about the distribution of oil, gas and water in the reservoir (capillary pressure data), residual oil saturation and multiphase flow characteristics (relative permeabilities). Measurements of electrical and acoustic properties are occasionally included in special core analysis. This information is mainly used in the interpretation of well logs.

The effect of pressure and temperature on rock and fluid properties is in some reservoir formations significant, and laboratory measurements should therefore be made at, or corrected to, reservoir conditions wherever possible. Included in special core analysis is in some cases detailed petro-graphical analysis of rocks (grain size distribution, clay identification, diagenesis etc.). Wettability analysis and special tests for enhanced oil recovery (EOR) are also often part of special core analysis. Figure 2.1 shows the kind of data obtained from the various special core analysis tests.

The following list gives some of the reference books in which the details of the subjects covered in this manual can be found.

- Amyx, J.W., Bass, D.M.Jr., Whiting, R.L. [1960],
- Archer, J.S., Wall, C.G., [1986]
- Koederitz, L.F., Harvey, A.H., Honarpour, M., [1989],
- Monicard, R.F., [1980],
- Whittaker, A., (ed.) [1985].

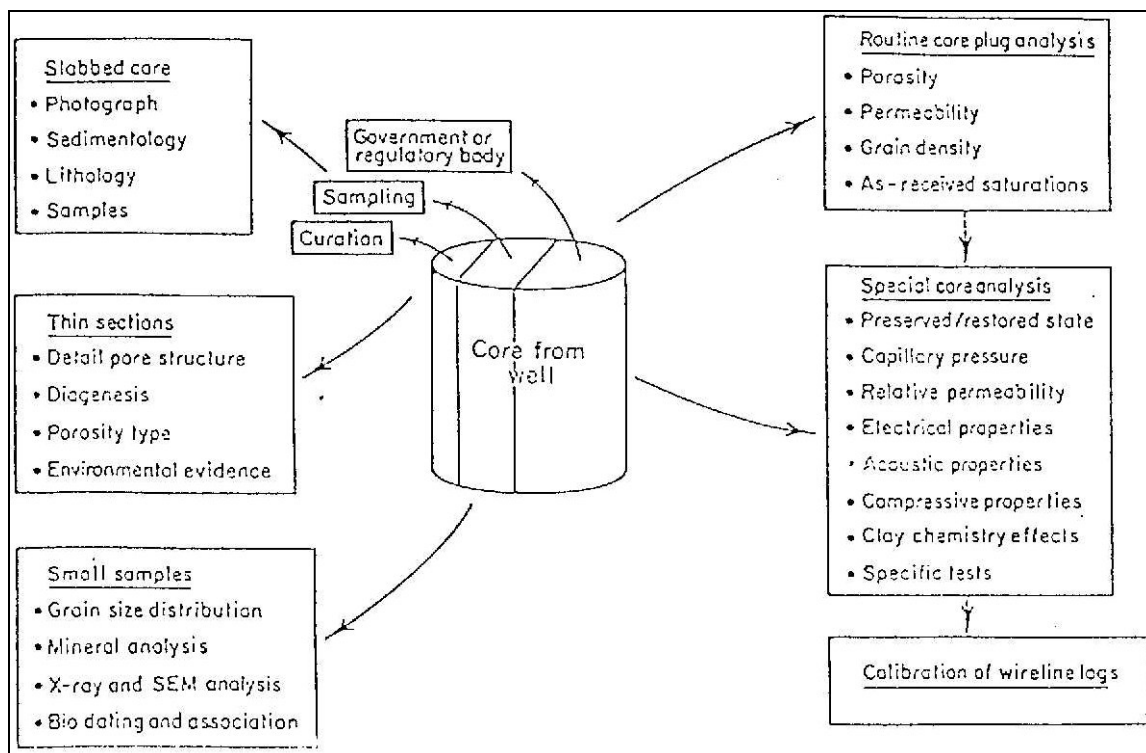

Figure 2.1 Data obtained from cored wells

3. POROSITY

3.1. Definitions

From the viewpoint of petroleum engineers, the two most important properties of a reservoir rock are porosity and permeability. Porosity is a measure of the storage capacity of a reservoir. It is defined as the ratio of pore volume to bulk volume, and it may be expressed as either a percent or a fraction. In equation form

$$\phi = \frac{\text{PoreVolume}}{\text{BulkVolume}} = \frac{\text{BulkVolume} - \text{GrainVolume}}{\text{BulkVolume}} \quad (3.1)$$

Two types of porosity may be measured: total or absolute porosity and effective porosity. Total porosity is the ratio of all the pore spaces in a rock to the bulk volume of the rock. Effective porosity ϕ_e is the ratio of interconnected void spaces to the bulk volume. Thus, only the effective porosity contains fluids that can be produced from wells. For granular materials such as sandstone, the effective porosity may approach the total porosity, however, for shales and for highly cemented or vugular rocks such as some limestones, large variations may exist between effective and total porosity.

Porosity may be classified according to its origin as either primary or secondary. Primary or original porosity is developed during deposition of the sediment. Secondary porosity is caused by some geologic process subsequent to formation of the deposit. These changes in the original pore spaces may be created by ground stresses, water movement, or various other types of geological activities after the original sediments were deposited. Fracturing or formation of solution cavities often will increase the original porosity of the rock.

For a uniform rock grain size, porosity is independent of the size of the grains. A maximum theoretical porosity of 47.6 % is achieved with cubic packing of spherical grains, as shown in Figure 2.1a. Rhombohedral packing, which is more representative of reservoir conditions, is shown in Figure 2.1b; the porosity for this packing is 26%. If a second, smaller size of spherical grains is introduced into cubic packing (Figure 3.1c), the porosity decreases from 47.6% to 14%. Thus, porosity is dependent on the grain size distribution and the arrangement of the grains, as well as the amount of cementing materials. Not all grains are spherical, and grain shape also influences porosity. Typical reservoir sand is illustrated in Figure 3.1d.

3.2. Effect of Compaction on Porosity

Compaction is the process of volume reduction due to an externally applied pressure. For extreme compaction pressures, all materials show some irreversible change in porosity. This is due to distortion and crushing of the grains or matrix elements of the material, and in some cases, re-crystallization. The variation of porosity with change in pressure can be represented by

$$\phi_2 = \phi_1 e^{C_f (P_2 - P_1)} \quad (3.2)$$

Where ϕ_2 and ϕ_1 are porosities at pressures P_2 and P_1 , respectively, and C_f is formation compressibility. Formation compressibility is defined as summation of both grain and pore compressibility. For most petroleum reservoirs, grain compressibility is considered to be negligible. Formation compressibility can be expressed as

$$C_f = - \frac{1}{V} \frac{dV}{dP} \quad (3.3)$$

Where dP is change in reservoir pressure. For porous rocks, the compressibility depends explicitly on porosity.

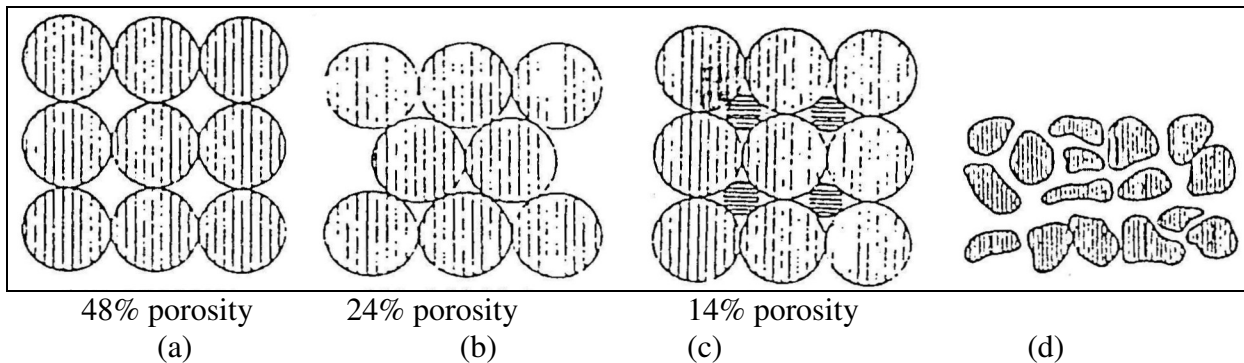

Figure 3.1 a) Cubic packing, b) rhombohedral packing, c) cubic packing with two grain sizes and d) typical sand with irregular grain shapes

3.3. Porosity Measurements

From the definition of porosity, it is evident that the porosity of a sample of porous material can be determined by measuring any two of the three quantities: bulk volume, pore volume or grain volume. The porosity of a reservoir rock may be determined by

- Core analysis
- Well logging technique
- Well testing.

The question as to which source of porosity data is more reliable cannot be answered without reference to a specific interpretation problem. These techniques will yield correct porosity values under favorable conditions. The core analysis porosity determination has the advantage that no assumptions need to be made as to mineral composition, borehole effects, etc. However, since the volume of the core is less than the rock volume which is investigated by a logging device, porosity values derived from logs are frequently more accurate in heterogeneous reservoirs.

In the following sections the estimation of pore-, grain- and bulk-volumes from core plugs will be discussed.

3.3.1. Bulk Volume Measurement

Although the bulk volume may be computed from measurements of the dimensions of a uniformly shaped sample, the usual procedure utilizes the observation of the volume of fluid displaced by the sample. The fluid displaced by a sample can be observed either volumetrically or gravimetrically. In either procedure it is necessary to prevent fluid penetration into the pore space to the rock. This can be accomplished (1) by coating the sample with paraffin or a similar substance, (2) by saturating the core with the fluid into which it is to be immersed, or (3) by using mercury.

Gravimetric determinations of bulk volume can be accomplished by observing the loss in weight of the sample when immersed in a fluid or by observing the change in weight of a pycnometer with and without the core sample.

3.3.2. Pore Volume Measurement

All the methods of measuring pore volume yield effective porosity. The methods are based on either the extraction of a fluid from the rock or the introduction of a fluid into the pore spaces of the rock.

One of the most used methods is the helium technique, which employs Boyle's law. The helium gas in the reference cell is isothermally expanded into a sample cell. After expansion, the resultant equilibrium pressure is measured. The helium porosimeter apparatus is shown schematically in Figure 3.2a.

Helium has advantages over other gases because: (1) its small molecules rapidly penetrate small pores, (2) it is inert and does not adsorb on rock surfaces as air may do, (3) helium can be considered as an ideal gas (i.e., $z = 1.0$) for pressures and temperatures usually employed in the test, and (4) helium has a high diffusivity and therefore affords a useful means for determining porosity of low permeability rocks.

A schematic diagram of the helium porosimeter is shown by Figure 3.2b. The helium in reference volume V_1 (cell A), at pressure P_1 , expands into the matrix cup with unknown volume V_2 (cell B), and initial pressure P_2 . The reference cell and the matrix cup are connected by tubing; the system can be brought to equilibrium when the core holder valve is opened, allowing determination of the unknown volume V_2 by measuring the resultant equilibrium pressure P . (Pressures P_1 and P_2 are controlled by the operator; usually $P_1 = 100$ and $P_2 = 0$ psig). When the core holder valve is opened, the volume of the system will be the equilibrium volume V , which is the sum of the volumes V_1 and V_2 . Boyle's law is applicable if the expansion takes place isothermally. Thus the pressure-volume products are equal before and after opening the core holder valve:

$$P_1V_1 + P_2V_2 = P(V_1 + V_2) \quad (3.4)$$

Solving the equation for the unknown volume, V_2 :

$$V_2 = \frac{P_1V_1 + P_2V_2}{P} - V_1 \quad (3.5)$$

Since all pressures in Eq. 2.5 must be absolute and it is customary to set $P_1 = 100$ psig and $P_2 = 0$ psig, Eq. 2.5 may be simplified as follows:

$$V_2 = \frac{V_1(100 - P)}{P} \quad (3.6)$$

Where V_2 in cm^3 is the unknown volume in the matrix cup, and V_1 in cm^3 is the known volume of the reference cell, P in psig is the pressure read directly from the gauge.

Small volume changes occur in the system, including the changes in tubing and fittings caused by pressure changes during equalization. A correction factor, G may be introduced to correct for the composite system expansion. The correction factor G is determined for porosimeters before they leave the manufacturer, and this correction is built into the gauge calibration in such way that it is possible to read the volumes directly from the gauge.

Another method of pore volume determination is to saturate the sample with a liquid of known density, and noting the weight increase (gravimetric method).

When a rock has a small fraction of void space, it is difficult to measure porosity by the mentioned methods. At this case, mercury injection will be used. The principle consists of forcing mercury under relatively high pressure into the rock pores. A pressure gauge is attached to the cylinder for reading the pressure under which measuring fluid is forced into the pores (Figure 3.3a). Figure 3.3b shows a typical curve from the mercury injection method. The volume of mercury entering the core sample is obtained from the device with accuracy up to 0.01 cm^3 .

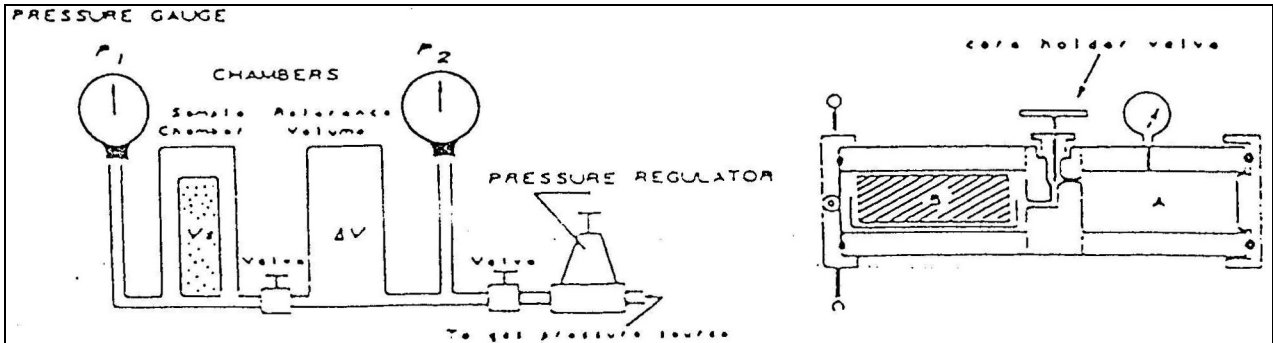

Figure 3.2 Schematic diagram of a) helium porosimeter apparatus and b) The helium porosimeter.

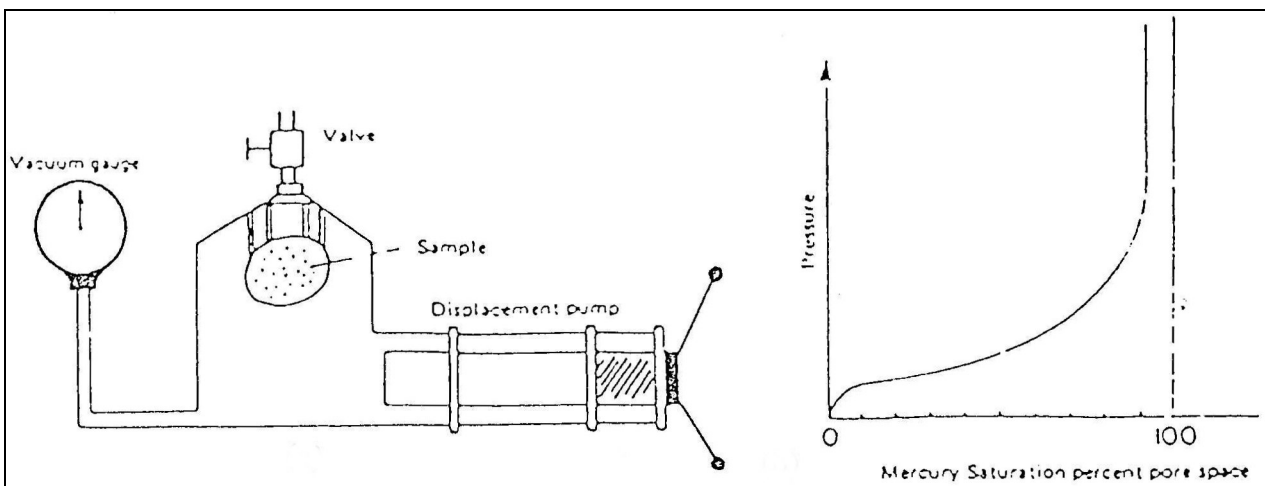

Figure 3.3 a) Mercury injection pump and b) porosity through mercury injection.

3.3.3. Grain Volume Measurement

The grain volume of core samples is sometimes calculated from sample weight and knowledge of average density. Formations of varying lithology and, hence, grain density limit applicability of this method. Boyle's law is often employed with helium as the gas to determine grain volume. The technique is fairly rapid, and is valid on clean and dry samples.

The measurement of the grain volume of a core sample may also be based on the loss in weight of a saturated sample plunged in a liquid.

Grain volume may be measured by crushing a dry and clean core sample. The volume of crushed sample is then determined by (either pycnometer or) immersing in a suitable liquid.

4. PERMEABILITY

4.1. Definition

Permeability is a property of the porous medium and is a measure of capacity of the medium to transmit fluids. Permeability is a tensor that in general is a function of pressure. Usually, the pressure dependence is neglected in reservoir calculations, but the variation with position can be pronounced. Very often the permeability varies by several magnitudes, and such heterogeneity will of course influence any oil recovery.

4.2. Darcy's Law

Darcy [1856] performed a series of experiments on the relationship affecting the downward flow of water through sands. The generalized equation called Darcy's law may be written in the form

$$\bar{u} = - \frac{\bar{k}}{\mu} (\nabla P + \rho \bar{g}) \quad (4.1)$$

Where \bar{u} is superficial velocity, \bar{k} is permeability tensor, \bar{g} is gravitational vector, μ is fluid viscosity, ∇P is pressure gradient, and ρ is fluid density. Writing flow velocity v as the ratio of volumetric rate to cross-sectional area perpendicular to flow q/A in distance L , Darcy's law can be expressed

$$\frac{q}{A} = v = \frac{k}{\mu} \frac{\Delta P}{L} \quad (4.2)$$

The dimensions of permeability can be established by substituting the units of the other in the equation. The unit Darcy results from the choice of cgs system units

$$\text{darcy}[D] = \frac{q[\text{cm}^3/\text{s}]\mu[\text{cp}]L[\text{cm}]}{\Delta P[\text{atm}]A[\text{cm}]} \quad (4.3)$$

The permeability in SI system has dimension of m^2 .

4.3. Kozeny-Carman Model

Formation permeability may be determined or estimated on the basis of core analysis, well tests, production data, well log interpretations, or correlations based on rock permeabilities. One of these often used pore models is Kozeny-Carman model [Carman, 1939].

The volumetric flow rate q in a horizontal capillary of radius R and length L , is given by Hagen-Poiseuille's equation

$$q = \frac{\pi R^4 \Delta P}{8 \mu L_t} \quad (4.4)$$

And the average velocity in the tube is

$$\bar{v} = \frac{q}{\pi R^2} = \frac{R^2 \Delta P}{8 \mu L_t} \quad (4.5)$$

This equation has to be transformed to the scale of a representative elementary volume (REV), The REV is defined as a volume below which local fluctuations in permeability is large. If we make the travel time in the capillary tube equal to that in a REV,

$$\left(\frac{L_t}{\bar{v}} \right)_t = \left(\frac{L}{v} \right)_{REV} \quad (4.6)$$

The relation between interstitial and superficial velocity is $v = u/\phi$. Darcy's law can be used to eliminate v and the permeability component k is obtained

$$k = \frac{R^2 \phi}{8 \tau} \quad (4.7)$$

Where $\tau = (L_t / L)^2$ is the tortuosity. This is an important permeability media property and is usually estimated from electrical resistivity measurements. The tortuosity is in the range of 2 to 5 for most reservoir rock.

The capillary radius R in Eq. 4.4 is difficult to define for a porous medium, but may be approximated by the hydraulic radius R_h that expresses the ratio between volume open to flow and the wetted surface area. For a porous and permeable media we have:

$$R_h = \frac{\pi R^2 L}{2 \pi R L} = \frac{R}{2} \xrightarrow{(2.4)} k = \frac{R_h^2 \phi}{2 \tau} \quad (4.8)$$

$$R_h = \frac{\phi}{a(1 - \phi)} \quad (4.9)$$

Where "a" is internal surface area per volume, an important intrinsic property of permeable media. By substituting these expressions for R_h in Eq. 4.7 and solving the equation for an assemblage of uniform spheres where $a = 6/D$ we get the Kozeny-Carman equation

$$k = \frac{1}{72 \tau} \frac{\phi^3 D^2}{(1 - \phi)^2} \quad (4.10)$$

Where D is sphere or particle diameter, and we see that permeability is a strong function of particle size and packing through ϕ . The Kozeny-Carman equation is often used to make order-of-magnitude estimates of pore size from knowledge of permeability. However, the capillary tube model is of limited value since it does not provide alternate pathways for fluid flow within each REV. The consequence is that relative permeabilities or trapped phase saturations can not be estimated, parameters of major importance in oil recovery processes.

4.4. Klinkenberg Effect

Klinkenberg [1941] has reported variations in permeability determined by using gases as the flowing fluid compared to those obtained when using non reactive liquids. These variations were considered to be due to slippage, a phenomenon well known with respect to gas flow in capillary tubes. The phenomena of gas slippage occurs when the diameter of the capillary openings approach the mean free path of the gas. The mean free path of a gas is a function of molecular size and the kinetic energy of the gas. Therefore, permeability of gas depends on factors which influence the mean free path, such as temperature, pressure and the molecular size of the gas.

Figure 4.1 is a plot of the permeability of a porous medium as determined at various mean pressure using three different gases. Note that for each gas a straight line is obtained for the observed permeability as a function of the reciprocal of the mean pressure of the test. All the lines when extrapolated to infinite mean pressure ($1/P_m = 0$) intercept the permeability axis at a common point. This point is designated k_L , or the equivalent liquid permeability.

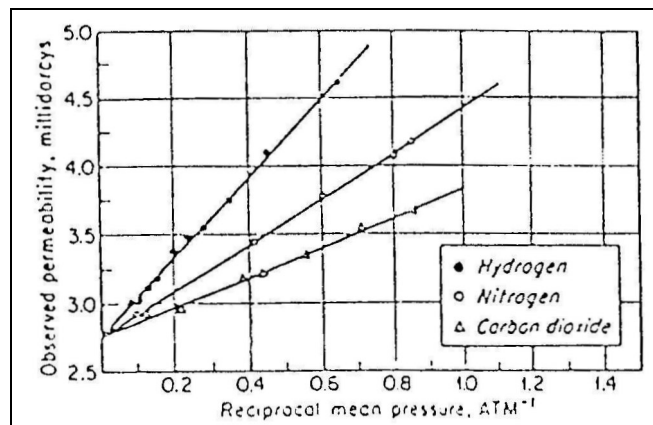

Figure 4.1 Variation in gas permeability with mean pressure and type of gas [Klinkenberg, 1941]

Klinkenberg has related apparent permeability k_a measured for gas for an average pressure P_m to the true permeability k_L by

$$k_a = k_L \left(1 + \frac{b}{P_m} \right) \quad (4.11)$$

Where b is constant depending upon the average free movement λ of the molecule at P_m

$$b = \frac{4 C' \lambda P_m}{r} \quad (4.12)$$

Where r is channel radius and $C' \approx 1$.

The constant b can be estimated by empirical relationships by studies of slippage phenomena in porous medium using different gases; but the correlation has a big disadvantage because it has to be modified for each formation and rock-type.

4.4.1. Ideal Gas Flow

Darcy's equation defining permeability is linked to laminar flow in porous media. This laminar flow is not always achieved especially in gas flows. Let us suppose that there is a metal tube filled with sand (Figure 4.2). Upstream and downstream pressures P_1 and P_2 are constant.

The mass flow m is the same in all slices and each slice is related to the volume flow rate Q by

$$m = Q \rho \quad (4.13)$$

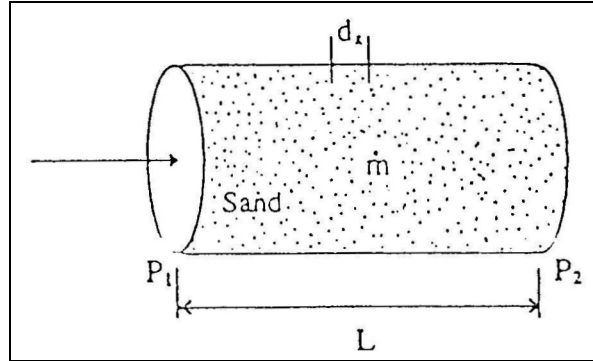

Figure 4.2 Linear flow of an ideal gas in sand-filled tube.

Where ρ is gas density in the slice when pressure is P . Using Boyle's law, relationship $\rho = bP$ can be applied where b is a constant and then

$$Q = \frac{1}{b P} m \quad (4.14)$$

By substituting Q in Darcy's equation, a differential relation between P and distance x may be obtained

$$b P dP = \frac{\mu}{A} \frac{m}{k} dx \quad (4.15)$$

After integration for distance L

$$\frac{b}{2} (P_1^2 - P_2^2) = \frac{\mu}{A} \frac{m}{k} L \quad (4.16)$$

And taking into account that $m = QbP$, we get

$$Q_{atm} = \frac{Ak}{\mu L} \frac{(P_1^2 - P_2^2)}{2 P_{atm}} \quad (4.17)$$

The gas-flow is measured at atmospheric conditions, thus $P_{atm} = 1 \text{ atm}$.

4.4.2. High Velocity Flow

For high flow rates, Darcy's law is not valid. The range of flow rate which laminar flow exists is dependent on the Reynolds number which is a dimensionless quantity. The Reynolds number for porous media is defined as

$$R_e^* = \frac{d v \rho}{\mu} \quad (4.18)$$

Where v is average velocity (q/A), ρ is fluid density, μ is viscosity and d is the average sand grain diameter. For example, in sand, the transition from laminar to turbulent flow occurs in the range of Reynolds number from 1 to 10. However, for porous media it is difficult to define a channel diameter.

Many models were suggested to replace or modify Darcy's law for high-velocity flow. The most accepted model for non-Darcy flow was proposed by Forchheimer [1901].

$$-\nabla P = a v + b v^2 \quad (4.19)$$

Where a and b are constants and $v = q/A$. Later work resulted in an equation in terms of fluid and rock properties

$$-\nabla P = \frac{\mu}{k} v + \beta \rho v^2 \quad (4.20)$$

Where β is high velocity coefficient, μ and ρ are the viscosity and the density of the gas. The high velocity coefficient is a property of the formation rock that accounts for the deviation from Darcy's law which is more pronounced in gas flow than in oil flow. Many correlations for β exist in the literature. Usually, β is taken as a property of the reservoir rock which may be estimated from

$$\beta = \frac{\text{constant}}{k^\alpha} \quad (4.21)$$

Where α is constant which can be determined experimentally from a known permeability formation.

5. CAPILLARY PRESSURE

5.1. Definitions

When two immiscible fluids are in contact in the interstices of a porous medium, a discontinuity in pressure exists across the interface separating them. The difference in pressure P_c is called capillary pressure, which is pressure in the non-wetting phase minus the pressure in the wetting phase

$$P_c = P_{non-wetting} - P_{wetting} \quad (5.1)$$

Thus, the capillary pressure may have either positive or negative values. For an oil-water, gas-water or gas-oil system, capillary pressure is defined as

$$P_c = P_o - P_w \quad ; \quad P_c = P_g - P_w \quad ; \quad P_c = P_g - P_o \quad (5.2)$$

The hydrostatic pressure of a liquid with density ρ is dependent on the elevation z as follows

$$\frac{dP}{dz} = \rho g \quad (5.3)$$

For an oil-water system, the capillary pressure becomes

$$\frac{dP_c}{dz} = (\rho_w - \rho_o)g \quad (5.4)$$

If fluid-columns are continuous in the reservoir, the following relationship holds

$$P_c(z) = P_c(z_0) + g \int_{z_0}^z (\rho_w - \rho_o) dz \quad (5.5)$$

Where $P_c(z)$ is capillary pressure at height z above z_0 and ρ_w , ρ_o are densities of water and oil, respectively.

The capillary pressure is a result of the curvature of fluid-interfaces, according to the well-known Laplace equation

$$P_c = \sigma \left(\frac{1}{r_1} + \frac{1}{r_2} \right) \quad (5.6)$$

Where σ is interfacial tension between the two fluids. r_1 , r_2 are principal radii of curvature.

The condition for capillary forces to exist is a certain curvature of the fluid-fluid interface. The relation between fluid saturation and capillary pressure in the reservoir is a function of pore sizes, wettability, interfacial tension and fluid saturation history (drainage and imbibition). Based on laboratory measurements of capillary pressure, it is possible to convert those into reservoir capillary pressure. From these values fluid saturations in the reservoir can be evaluated.

An example of the capillary pressure versus saturation relationship (capillary pressure function) is shown in Figure 5.1. It is apparent that the relationship between capillary pressure and saturation is not unique, but depends on the saturation history of the system. Definitions of the main terms are as follows:

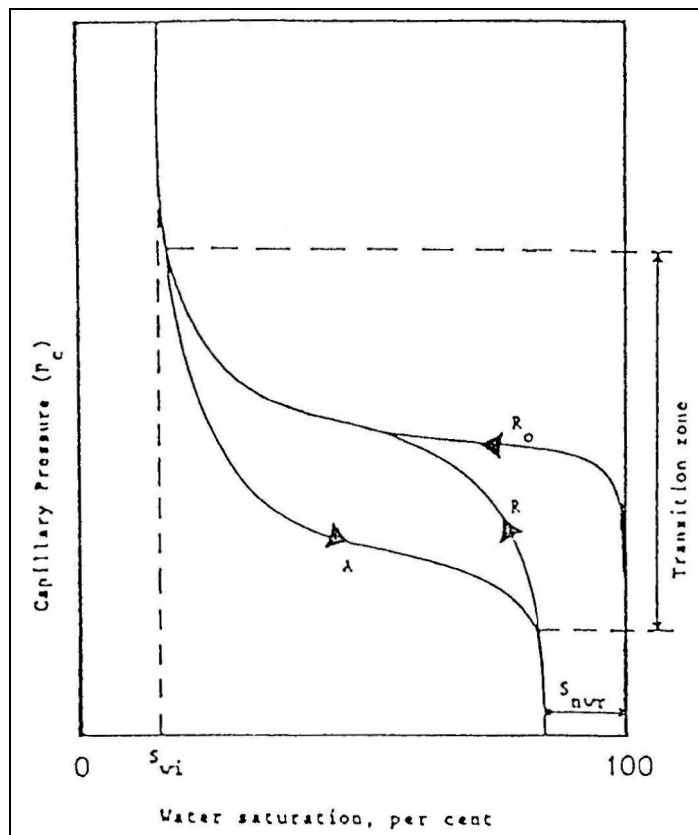

Figure 5.1 Typical capillary pressure curve.

Irreducible saturation S_{wi} : the reduced volume of the wetting phase retained at the highest capillary pressures where the wetting phase saturation appears to be independent of further increases in the externally measured capillary pressure.

Residual saturation S_{nwr} : the reduced volume of the non-wetting phase which is entrapped when the externally measured capillary pressure is decreased from a high value to zero.

Initial drainage curve (R_o in Figure 5.1): the relationship characteristic of the displacement of the wetting phase from 100% saturation to the irreducible saturation.

Imbibition curve (A in Figure 5.1): the relationship characteristic of the displacement of the non-wetting phase from the irreducible saturation to the residual saturation.

Secondary drainage curve (R in Figure 5.1): the relationship characteristic of the displacement of the wetting phase from residual saturation to the irreducible saturation.

Most experimental evidences indicate that the irreducible saturation obtained by initial drainage is the same as that obtained by secondary drainage. When the residual saturation is the same, the imbibition after secondary drainage will follow exactly the imbibition curve obtained after initial drainage. Thus, the secondary drainage curve and the imbibition curve constitute a closed and reproducible hysteresis loop (R_A in Figure 5.1).

The capillary pressure hysteresis as can be seen in Figure 5.1 is a result of the different mechanisms governing filling/emptying of pores with a non-wetting or a wetting fluid, respectively. Contact angle hysteresis is one factor also contributing to hysteresis.

5.2. Capillary Pressure Measurement Methods

5.2.1. Porous Plate Method (restored state)

Water saturated samples for air-water or oil-water tests and oil saturated cores for air-oil tests are placed on a semi-permeable diaphragm, and a portion of the contained liquid is displaced with the appropriate fluid of air or oil. A schematic diagram of an apparatus for performing such tests is seen in Figure 5.2. It consists of a cell for imposing pressure, a semi-permeable diaphragm C, a manometer for recording pressure M, and a measuring burette for measuring produced volumes.

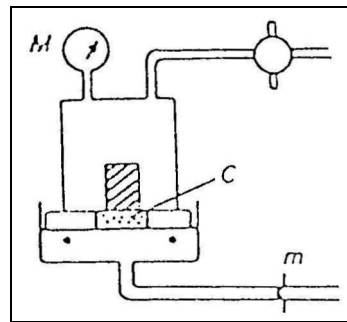

Figure 5.2 The porous plate method assembly.

During measurement, the pressure is increased in steps and final equilibrium produced volumes of the wetting phase are recorded for each step.

The porous plate method is slow and one full curve may take up to 40 days or more to obtain. However, equipment needed for this method is simple and inexpensive and the work needed is limited to some volume reading during the process. Several samples may be run in one chamber. Then the samples have to be removed in order to weigh them separately between each pressure increase.

This method is regarded as the standard method against which all other methods are compared. Routinely only the drainage curve is measured, but with appropriate modifications the imbibition curve may be determined in the same manner. The weakness, as with all the other methods, is the transformation of data to reservoir conditions.

5.2.2. Centrifuge Method

Hassler and Brunner [1945] presented the basic concepts involved in the use of the centrifuge by relating the performance of a small core in a field of high acceleration.

If a cylindrical core of length L is subjected to an acceleration as $a_c = -\omega^2 r$ where ω is angular velocity of the centrifuge and r is the distance from the axis of rotation, then from Eq. (5.4) we have

$$\frac{\partial P_c}{\partial r} = \Delta \rho a_c \quad (5.7)$$

Given the boundary conditions shown in Figure 5.3, the differential equation can be solved by simple integration

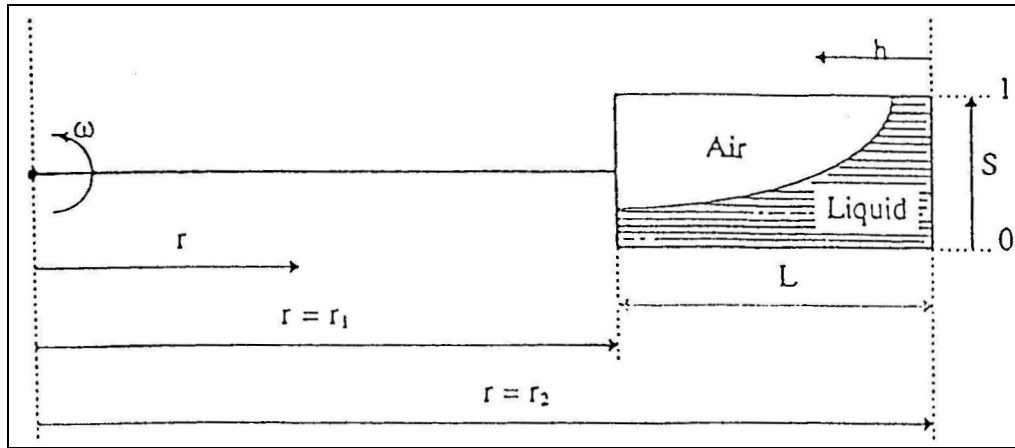

Figure 5.3 Schematic diagram of a core in a centrifuge and its boundary conditions.

$$P_c = \int_{r_2}^r \Delta \rho a_c dr \quad (5.8)$$

$$P_c(r) = - \int_{r_2}^r \Delta \rho \omega^2 r dr \quad (5.9)$$

The capillary pressure at the outer face of the core is zero, $P_c(r_2) = 0$, so

$$P_c(r) = \frac{1}{2} \Delta \rho \omega^2 (r_2^2 - r^2) \quad (5.10)$$

And for a continuous phase, the capillary pressure at the inner face of the core is

$$P_{cL} = P_c(L) = \frac{1}{2} \Delta \rho \omega^2 (r_2^2 - r_1^2) \quad (5.11)$$

Now, the main purpose is to relate the capillary pressure and saturation S for a given core which gives the saturation in the core at equilibrium with the capillary pressure, $S = S(P_c)$.

The saturation at a distance h above the outer face of the core can not be measured directly. However, the average saturation which is the ratio of remaining liquid volume after production to pore volume can be written as

$$\bar{S} = \frac{1}{r_2 - r_1} \int_{r_1}^{r_2} S(r) dr \quad (5.12)$$

Equation 5.12 is a relationship of saturation as a function of capillary pressure, $S = S(P_c)$, which can be expressed as follows by changing integration variable

$$P_c(r_2) = 0 \quad \text{and} \quad P_c(r_1) = P_{cL}$$

$$\bar{S} = \frac{I}{r_2 - r_1} \int_{P_{cL}}^0 \frac{S(P_c) dP_c}{-\Delta\rho\omega^2 r} \quad (5.13)$$

An expression for r is obtained from Eq. 5.10

$$r = r_2 \sqrt{1 - \frac{P_c}{\frac{1}{2} \Delta\rho\omega^2 r_2^2}} \quad (5.14)$$

And we obtain

$$\bar{S} = \frac{I}{(r_2 - r_1)\Delta\rho\omega^2 r_2} \int_0^{P_{cL}} \frac{S(P_c) dP_c}{\sqrt{1 - \frac{P_c}{\frac{1}{2} \Delta\rho\omega^2 r_2^2}}} \quad (5.15)$$

And with mathematical manipulation it becomes

$$\bar{S} P_{cL} = \cos^2(\alpha/2) \int_0^{P_{cL}} \frac{S(P_c) dP_c}{\sqrt{1 - \frac{P_c}{P_{cL}} \sin^2 \alpha}} \quad (5.16)$$

Where

$$\cos \alpha = \frac{r_1}{r_2}$$

Then

$$\cos^2(\alpha/2) = \frac{1}{2}(1 + \cos \alpha) = \frac{r_1 + r_2}{2r_2} \quad ; \quad \sin^2 \alpha = 1 - \cos^2 \alpha = 1 - \frac{r_1^2}{r_2^2}$$

Eq. 5.16 can not be solved so simply for the unknown function S. For small values of a (small core sample), the acceleration gradient along the core can be neglected. Assuming

$$\frac{r_1}{r_2} \approx 1$$

Then

$$\cos^2(\alpha/2) = 1 \quad ; \quad \sin^2 \alpha = 0$$

Eq. 5.16 is then reduced to

$$\bar{S} P_{cL} = \int_0^{P_{cL}} S(P_c) dP_c \quad (5.17)$$

Or in differentiation form

$$S_L = \frac{d}{dP_{cL}} (\bar{S} P_{cL}) \quad (5.18)$$

In this method the cores are saturated with water (or oil) and rotated at increasing speed. The speed is increased in steps, and average fluid saturations at each speed is calculated from observation of liquid produced. The liquid volume is read with a stroboscope while the centrifuge is in motion, and the speed of centrifuge is increased stepwise. When the run is over the cores are removed and weighed.

The values of P_{cL} for each centrifuge speed are then computed from Eq. 5.11, and the average saturation of each core is obtained from the dry and saturated weights and the corresponding pipette reading. From these data a smooth curve is prepared for each core.

Figure 5.4a shows a typical as a function of P_{cL} and points indicated on the curve are first, second and third speed.

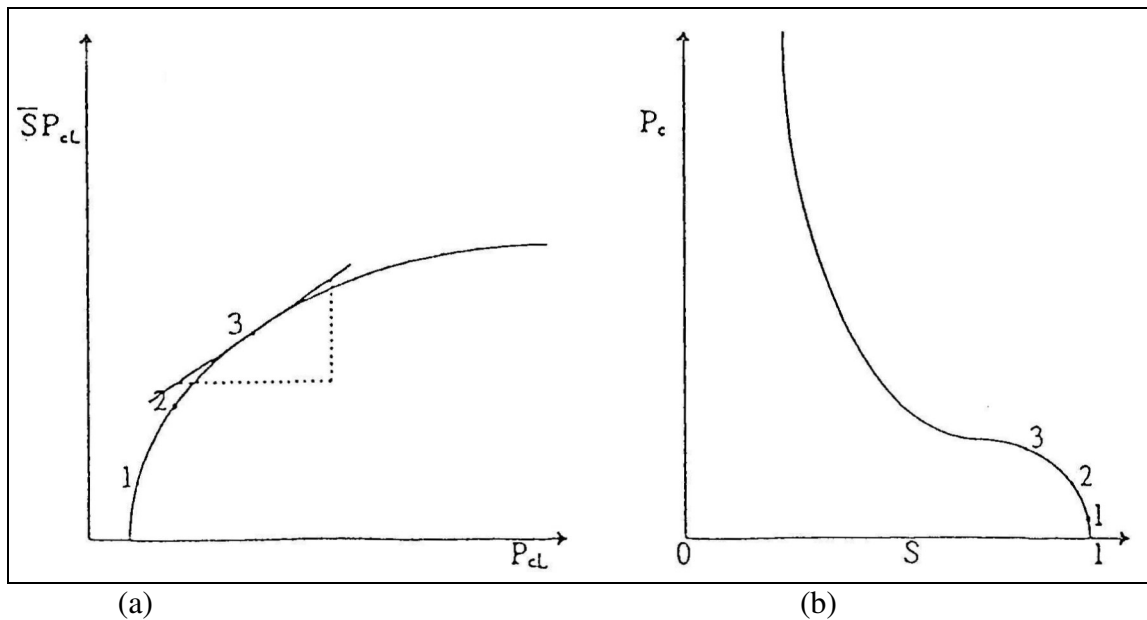

Figure 5.4 a) Graphical differentiation of $\bar{S}P_{cL} - P_{cL}$ curve to determine b) $S - P_{cL}$ curve.

The values of the saturation that goes with each value of P_{cL} which now represents the capillary pressure, is obtained from this curve by graphical differentiation according to Eq.5.18. A typical plot of P_c as a function of S is shown in Figure 5.4b.

A complete capillary pressure curve by this method may be obtained in a few hours, and several samples are run simultaneously. The method is claimed to be accurate, to reach equilibrium rapidly, give good reproducibility, and is able to produce high pressure differences between phases.

The calculation of capillary pressure by the centrifuge method involves not a straightforward mathematical derivation. There are capillary transition zones during displacement, and these may complicate the interpretation and may even dominate the core sample because of its small size.

5.2.3. Mercury injection (Purcell - 1949) Method

The test specimen is evacuated and mercury is injected in increments into the core at increasing pressure levels. When the entry pressure is reached, one can easily determine the bulk volume of the core. A mercury injection apparatus is schematically shown in Figure 5.5. The equipment consists basically of a mercury injection pump, a sample holder cell with a window for observing constant mercury level, manometers, vacuum pump, and a pressurized gas reservoir.

In this method the mercury injected is calculated as a percentage of pore volume and related to pressure. A practical pressure limit on most equipment is about 15-25 MPa, but equipment for 150 MPa also exists.

Two important advantages are gained with the mercury injection method: (1) the time for determining a complete curve is reduced to less than one hour, and (2) the range of pressure is increased compared with the other methods. However, this method is a destructive method and it is difficult to transform the results to reservoir conditions because of the highly unrealistic fluid system and the uncertainty of wetting of mercury-solid.

Using mercury-air as the fluid-pair, one will not obtain the irreducible saturation as when displacing water with air.

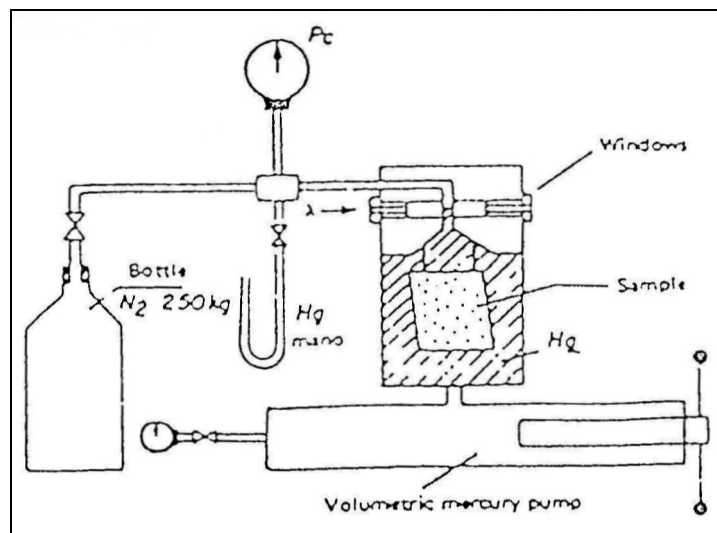

Figure 5.5 Apparatus for mercury injection method.

5.2.4. Dynamic Method

The main feature in this method is the way it controls the capillary pressure at both ends of the sample. This is accomplished by placing the tested core between two membranes, or porous plates, which are permeable only to the wetting fluid (Figure 5.6). This permits maintenance of a uniform saturation throughout the length of the core even at low flow rates.

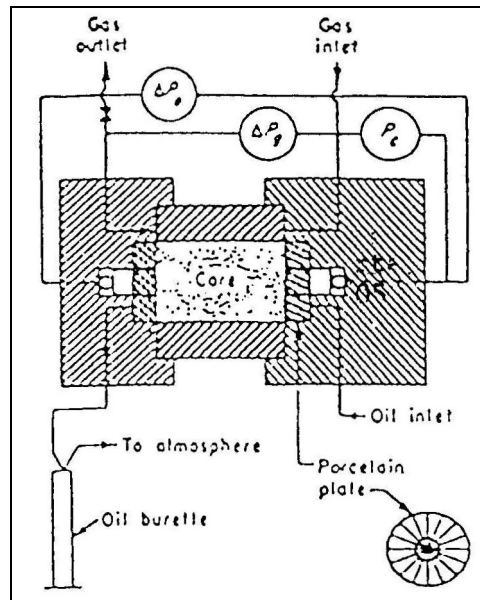

Figure 5.6 Dynamic capillary pressure apparatus.

The membranes permit separate pressure measurements in each of the two phases. The capillary pressure is then equal to the pressure difference between the non-wetting phase and the wetting one at the inflow face. When equilibrium is reached, the sample is removed and its saturation is determined by weighing.

5.2.5. Comparison of Methods

In Table 5.1 advantages and disadvantages of the methods are listed. The mercury injection method is primarily used for obtaining pore size distribution data, since it is a destructive method. Mercury-air capillary pressure curves have been found to be similar to water-air capillary pressure curves when the mercury-air pressure is divided by a constant. The constant can range from 5.8 to 7.5, depending on the nature of the rock.

The porous plate method is the simplest method conceptually and it must be regarded as the standard method. Small and large samples can be used, and the choice of fluids is not restricted. A serious drawback is the limitation in pressure, since most equipment is limited to about 5 atm.

The centrifuge can reach capillary pressures higher than the porous plate method, and a large number of samples can be run in short time. The accuracy of this method is questioned.

Table 5.1 Comparison of methods

Method	Fluid type	Pc curve type	Max.ΔP in lab (atm)	Test time
Porous Plate	oil-water gas-water gas-oil	Imbibition Drainage	2 - 5	weeks
Centrifuge	oil-water gas-water gas-oil	(Imbibition) Drainage	10	hours
Dynamic	oil-water gas-water gas-oil	(Imbibition) Drainage	1 - 10	days
Mercury Injection	Hg-air	Drainage	100	minutes

5.3. Converting Laboratory Data

To use laboratory capillary pressure data in reservoir evaluation it is necessary to convert to reservoir conditions. Laboratory data are obtained with a gas-water or an oil-water system, which does not normally have the same physical properties as the reservoir water, oil and gas system.

By means of the capillary tube, the capillary pressure is expressed as

$$P_c = \frac{2\sigma \cos \theta}{r} \quad (5.19)$$

Considering two specific cases wherein the laboratory and reservoir values are determined with gas-water and water-oil respectively. The capillary pressures become

$$(P_c)_L = \frac{2\sigma_{wg} \cos \theta_{wg}}{r} \quad \text{and} \quad (P_c)_R = \frac{2\sigma_{wo} \cos \theta_{wo}}{r} \quad (5.20)$$

Where

- σ_{wg} = interfacial tension between gas and water used in laboratory test
- θ_{wg} = contact angle between water and gas
- σ_{wo} = interfacial tension between reservoir water and oil at reservoir conditions
- θ_{wo} = contact angle between reservoir, water and oil
- r = radius of capillary.

Comparing the equations for laboratory and reservoir capillary pressure and assuming the radius of capillary constant with pressure and temperature, it is found that the reservoir capillary pressure is

$$(P_c)_R = \frac{\sigma_{wo} \cos \theta_{wo}}{\sigma_{wg} \cos \theta_{wg}} (P_c)_L = \frac{(\sigma \cos \theta)_R}{(\sigma \cos \theta)_L} (P_c)_L \quad (5.21)$$

Note that it is difficult to determine the exact value of the contact angle for fluids in a porous matrix, and therefore the contact angles are often neglected. The equation becomes

$$(P_c)_R = \frac{\sigma_R}{\sigma_L} (P_c)_L \quad (5.22)$$

5.4. Pore-size distribution

As noted in the capillary pressure curves previously presented, the capillary pressure is a function of the fluid properties and of the saturation. For a given rock-fluid system and saturation history, the saturation at a given capillary pressure is some function of the pore geometry. If the porous medium is conceived to be a bundle of capillary tubes of various radii, then the capillary pressure-saturation curve relates the number and size of pores penetrated by the non-wetting fluid at a given capillary pressure.

Purcell [1949] and Burdine et al. [1950] both have reported on computation of permeability from capillary pressure data obtained by the mercury injection method. Purcell [1949] utilized the concept of pore-size distribution without evaluating the distributions. He applied the data directly to the computation of permeability. Burdine et al. [1950] reported pore-size distributions as well as the results of computation of permeability.

5.4.1. Pore Size Distribution of Reservoir Rocks Burdine et al. [1950]

Burdine et al. [1950] adapted the method of Ritter and Drake [1945] and also presented a method of calculating permeability from this distribution. The method involves injection of mercury into an evacuated core sample, thus obtaining a mercury capillary pressure curve. The equations for calculating the pore size and rock permeability are derived as follows:

A distribution function is defined as $D(r_i)$, so that

$$dV = D(r_i) dr \quad (5.23)$$

Where dV is the total volume of all pores having a radius between r_i and $r_i - dr$. The quantity $D(r_i)$ can be computed from the mercury capillary pressure data by using the following two equations:

$$P_{ci} r_i = 2\sigma \cos \theta \quad (5.24)$$

$$D(r_i) = \frac{P_{ci}}{r_i} \frac{dS_m}{dP_c} \quad (5.25)$$

Where

P_{ci} = capillary pressure

r_i = pore entry radius

σ = interfacial tension

θ = contact angle

S_m = mercury saturation, per cent of pore volume

The distribution function can be evaluated by graphically taking slopes of the mercury capillary pressure curve at different values of mercury saturation, computing the pore radius from the capillary pressure corresponding to the point at which the slope was taken by means of Eq. 5.24, and evaluating Eq. 5.25 for the distribution function.

A typical mercury capillary pressure curve and the corresponding distribution curve are presented in Figures 5.7a and 5.7b. The area under the distribution curve to a given radius is the fraction of the volume having pores larger than the given radius.

The permeability equation developed by Burdine et al. [1950] is based on an analogy to a bundle of capillary tubes.

$$k = \frac{100\phi}{8(9.87 \times 10^{-7})} \sum_{i=1}^{i=n} \frac{\Delta S_m r_i^{-4}}{x_i^2 r_i^{-2}} \quad (5.26)$$

Where

r_i = pore entry radius, cm

ΔS_m = incremental change in mercury saturation

ϕ = fractional porosity

x_i^2 = factor to account for more complex geometry of system and termed dividing factor.

Empirically determined values of dividing factors as a function of permeability can be found from Burdine et al. [1950].

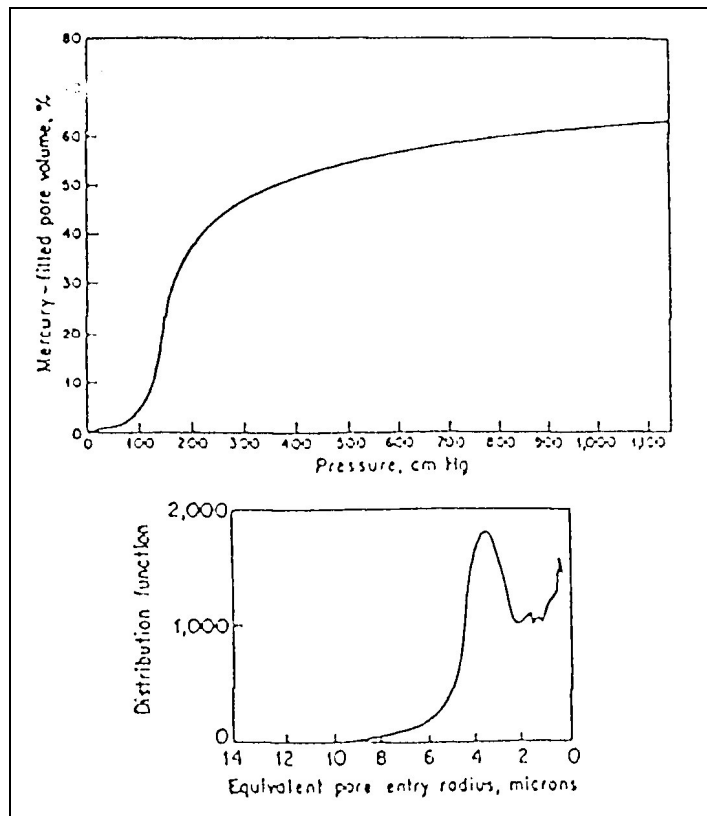

Figure 5.7 Mercury capillary pressure curve Burdine et al. [1950]

6. SURFACE AND INTERFACIAL TENSION

6.1. Definition

Surface and interfacial tension of fluids result from molecular properties occurring at the surface or interface. Surface tension is the tendency of a liquid to expose a minimum free surface. Surface tension may be defined as the contractile tendency of a liquid surface exposed to gases. The interfacial tension is a similar tendency which exists when two immiscible liquids are in contact. In the following, interfacial tension will be denoted for both surface and interfacial tension.

Figure 6.1 shows a spherical cap which is subjected to an interfacial tension σ around the base of the cap and two normal pressures P_1 and P_2 at each point on the surface. The effect of the interfacial tension σ is to reduce the size of the sphere unless it is opposed by a sufficiently great difference between pressures P_1 and P_2 .

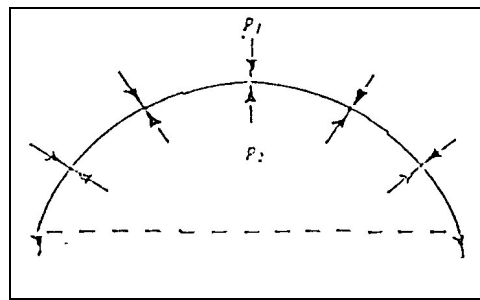

Figure 6.1 Capillary equilibrium of a spherical cap.

The Young-Laplace equation for the mechanical equilibrium of an arbitrary surface is

$$P_2 - P_1 = \sigma \left(\frac{1}{r_1} + \frac{1}{r_2} \right) \quad (6.1)$$

Where r_1 and r_2 are the principal radii of curvature. Introducing the mean radius of curvature r_m defined by

$$\frac{1}{r_m} = \frac{1}{2} \left(\frac{1}{r_1} + \frac{1}{r_2} \right) \quad (6.2)$$

The Young-Laplace equation becomes

$$P_2 - P_1 = \frac{2\sigma}{r_m} \quad (6.3)$$

Note that the phase on the concave side of the surface must have a pressure P_2 which is greater than the pressure P_1 on the convex side.

The surface tension of a liquid surface in contact with its own vapor or with air is found to depend only on the nature of the liquid, and on the temperature. Usually, surface tensions decrease as temperature increases.

6.2. Methods of Interfacial Tension Measurements

6.2.1. Capillary Rise Method

This method is based on rising of a liquid in a capillary tube and the fact that the height of the liquid, depends on interfacial tension. Let us consider a circular capillary tube of radius r , wetted by the liquid to be tested. The liquid with density ρ immediately rises to a height h above the free liquid level in the vessel (Figure 6.2). The column of liquid in the capillary must be held up against the gravity pull by a force, the so-called capillary suction. We may write

$$2\pi r\sigma \cos\theta \text{ (capillary suction)} = g\rho h\pi r^2 \text{ (gravity pull)}$$

Where θ is contact angle between liquid and glass tube and g is acceleration of gravity.

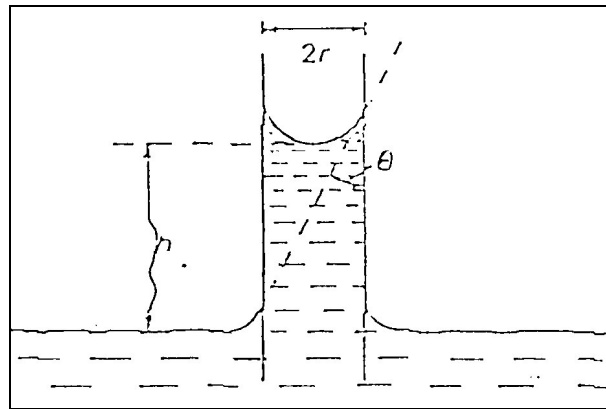

Figure 6.2 Capillary-rise method

Hence the value of σ is calculated by

$$\sigma = \frac{g\rho hr}{2 \cos \theta} = \frac{2\Delta P}{2 \cos \theta} \quad (6.4)$$

Where ΔP is the hydrostatic pressure of the column of liquid in the capillary.

6.2.2. Wilhelmy Plate Method

A thin plate of glass or platinum will “carry” or hold up part of liquid which is in contact with the plate. The dynamic measurement of interfacial tension is shown in Figure 5.3a. In this method, the necessary force to break the liquid film at this position will be determined

$$F = W_p + 2(x + y)\sigma \quad (6.5)$$

Where $2(x+y)$ is the contact area between the liquid and the plate, and W_p is the weight of the plate.

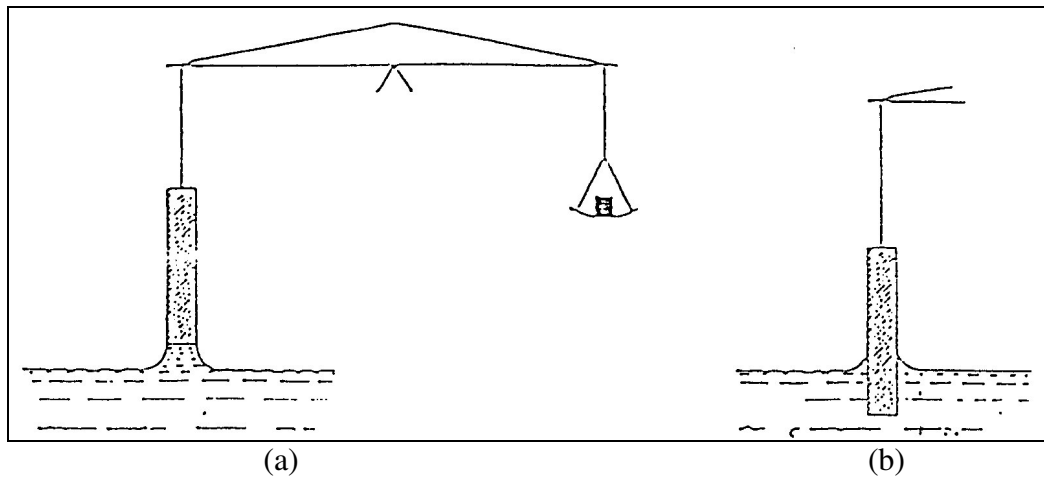

Figure 6.3 Wilhelmy plate methods; Dynamic (a) and static method (b).

In the static method the plate is held at the position shown in Figure 3b, and the equation will be

$$F = W_p - b + 2(x + y)\sigma \cos \theta \quad (6.6)$$

Where b is buoyancy force of immersed part of the plate in the liquid and θ is contact angle.

The instrument can be calibrated such that the interfacial tension reads directly.

6.2.3. Ring Method

The ring or du Noüy method of measuring surface and interfacial tension is commonly used and the apparatus is called a ring tensiometer.

To measure interfacial tension, a platinum ring is placed in the test liquid. The force necessary to withdraw it from the liquid is determined (Figure 6.4). When the ring is completely wetted by the liquid ($\theta = 0$), this equation is obtained

$$F = W_r - b + 2(2\pi r\sigma) \quad (6.7)$$

Where F is measured force, r is radius of the ring at center (the radius of the platinum thread is negligible compared to r), W_r is weight of the ring in air and b is buoyancy force of the ring immersed in the liquid. For interfacial measurements, the ring is placed in the interface and the force necessary to break the interfacial film with the ring is determined.

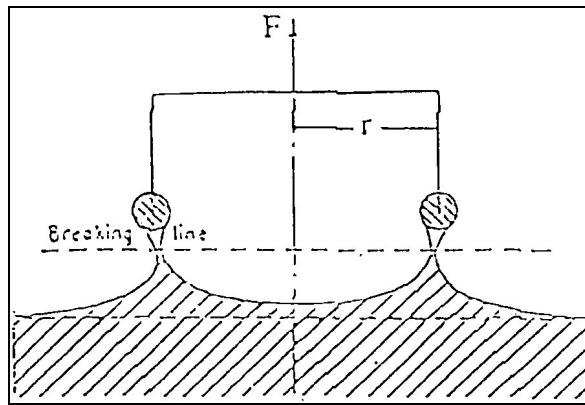

Figure 6.4 Ring method

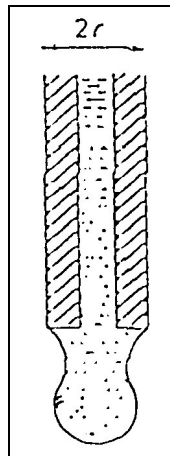

Figure 6.5 Hanging drop from a capillary tube.

The instrument can be regulated in such a way that the ring weight and buoyancy effect are taken care of with a correction factor C:

$$\sigma = C \frac{F}{2(2\pi r)} \tag{6.8}$$

6.2.4. Drop Weight Method

The drop weight method of measuring the interfacial tension of liquid with respect to air consists in determining the number of drops falling from a capillary. The drops are allowed to fall into a container until enough have been collected so that the weight per drop can be determined accurately. The principle of the method is that the size of a drop falling from a capillary tube depends on the surface tension of the liquid (Figure 5.5).

The maximum amount of liquid W which can hang from a capillary tube with radius r without falling depends on the surface tension as

$$W = mg = 2\pi r\sigma \tag{6.9}$$

Where m is mass per drop. Observations of falling drops show that a considerable portion of the drop (up to 40%) may remain attached to the capillary end. This effect will be compensated with a correction factor f

$$\sigma = f \frac{mg}{2\pi r} \quad (6.10)$$

The correction factor f varies in the region of 0.5 to 1.0. The drop method can be used for the determination of both gas-liquid and liquid-liquid interfacial tensions.

6.2.5. Pendant Drop Method

Small drops will tend to be spherical because surface-forces depend on the area in principle, one can determine the surface tension from measurements of the shape of the drop. In the case of the pendant drop, the most convenient and measurable shape dependent quantity is $S = d_s/d_d$. As indicated in Figure 6.6, d_e is the equatorial diameter and d_s is the diameter measured distance d_e from the bottom of the drop. The interfacial tension can be calculated by following equation

$$\sigma \frac{\Delta\rho g d_e^2}{H} \quad (6.11)$$

Where H is a shape determining variable. The relationship between the shape dependent quantity H and the experimentally measured shape dependent quantity S is determined empirically. A set of quite accurate $1/H$ versus S values is obtained in form of tables (Table 6.1). The quantity of S will be calculated after measuring d_e and d_s from shape of the pendant, and then $1/H$ can be determined from Table 6.1.

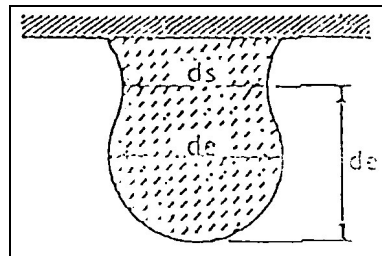

Figure 6.6 Relationship between dimensions of a pendant drop

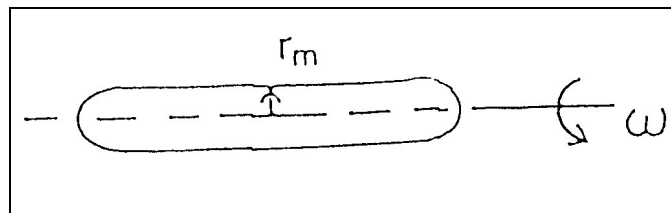

Figure 6.7 Schematic diagram of a spinning drop.

The pendant drop method is widely used and has good accuracy.

6.2.6. Spinning Drop

In this method, a drop of the less dense fluid is injected into a container of the denser fluid, and the whole system is rotated as shown in Figure 6.7. In the resulting centrifugal field, the drop elongates along the axis of rotation. Interfacial tension opposes the elongation because of the increase in area and a configuration which minimizes system free energy is reached. The method is similar to that for the pendant drop with the gravitational acceleration g replaced by the appropriate acceleration term for a centrifugal field.

If the fluid densities are ρ_A and ρ_B , and the angular velocity ω of rotation are known, then interfacial tension can be calculated from the measured drop profile. When drop length is much greater than the radius r_m , the following approximate expression holds

$$\sigma = \frac{(\rho_B - \rho_A)\omega^2 r_m^3}{4} \quad (6.12)$$

The spinning drop device has been widely used in recent years to measure very low interfacial tensions. Unlike the other methods, no contact between the fluid interface and a solid surface is required.

7. LIQUID DENSITY

7.1. Definitions

Density (ρ) is defined as the mass of the fluid per unit volume. In general, it varies with pressure and temperature. The dimension of density is kg/m^3 in SI or lb/ft^3 in the English system.

Specific gravity (γ) is defined as the ratio of the weight of a volume of the liquid to the weight of an equal volume of water at the same temperature. The specific gravity of liquid in the oil industry is often measured by some form of hydrometer that has its special scale. The American Petroleum Institute (API) has adopted a hydrometer for oils lighter than water for which the scale, referred to as the API scale, is

$$^{\circ}API = \frac{141.5}{\gamma} - 131.5 \quad (7.1)$$

Note: When reporting the density the units of mass and volume used at the measured temperature must be explicitly stated, e.g. grams per milliliter (cm^3) at $T(^{\circ}\text{C})$. The standard reference temperature for international trade in petroleum and its products is 15°C (60°F), but other reference temperatures may be used for other special purposes.

7.2. Measurement of density

The most commonly used methods for determining density or specific gravity of a liquid are

1. Westphal balance
2. Specific gravity balance (chain-o-matic)
3. API hydrometer
4. Pycnometer
5. Bicapillary pycnometer.

The first two methods are based on the principle of Archimedes: A body immersed in a liquid is buoyed up by a force equal to the weight of the liquid it displaces. A known volume of the liquid to be tested is weighed by these methods. The balances are so constructed that they should exactly balance in air.

The API hydrometer is usually used for determining oil gravity in the oil field. When a hydrometer is placed in oil, it will float with its axis vertical after it has displaced a mass of oil equal to the mass of hydrometer (Figure 7.1a). The hydrometer can be used at atmospheric pressure or at any other pressure in a pressure cylinder.

The pycnometer (Figure 7.1b) is an accurately made flask which can be filled with a known volume of liquid. The specific gravity of liquid is defined as the ratio of the weight of a volume of the liquid to the weight of an equal volume of water at the same temperature. Both weights should be corrected for buoyancy (due to air) if a high degree of accuracy is required. The ratio of the differences between the weight of the flask filled with liquid and empty weight, to the weight of the flask filled with distilled water and empty weight, is the specific gravity of the unknown fluid. The water and the liquid must both be at the same temperature.

The bicapillary pycnometer (Figure 7.1c) is another tool for accurate determination of density. The density of the liquid sample drawn into the pycnometer is determined from its volume and weight.

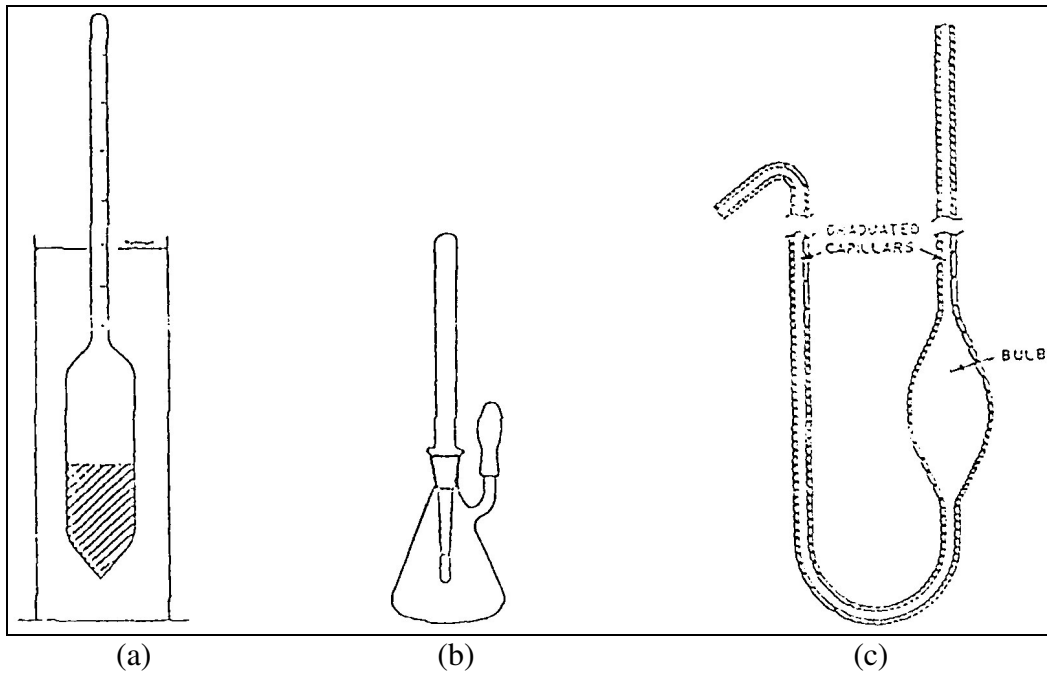

Figure 7.1 Schematic diagrams of the hydrometer (a), pycnometer (b), and bicapillary pycnometer (c).

8. VISCOSITY

8.1. Definitions

Viscosity is defined as the internal resistance of fluid to flow. The basic equation of deformation is given by

$$\tau = \mu\gamma \quad (7.1)$$

Where τ is shear stress, γ is the shear rate and μ is the viscosity. The term τ can be defined as F/A where F is force required to keep the upper plate moving at constant velocity v in the x -direction and A is area of the plate in contact with the fluid (Figure 8.1). By fluid viscosity, the force is transmitted through the fluid to the lower plate in such a way that the x -component of the fluid velocity linearly depends on the distance from the lower plate.

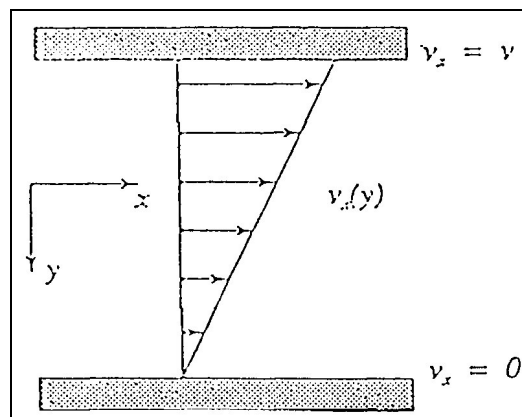

Figure 8.1 Steady-state velocity profile of a fluid entrained between two flat surfaces.

It is assumed that the fluid does not slip at the plate surface. Newtonian fluids, such as water and gases, have shear-independent viscosity and the shear stress is proportional to the shear rate (Figure 8.2).

In the oil industry viscosity generally is expressed in centipoises, cp ($1 \text{ cp} = 10^{-3} \text{ Pa}\cdot\text{s}$).

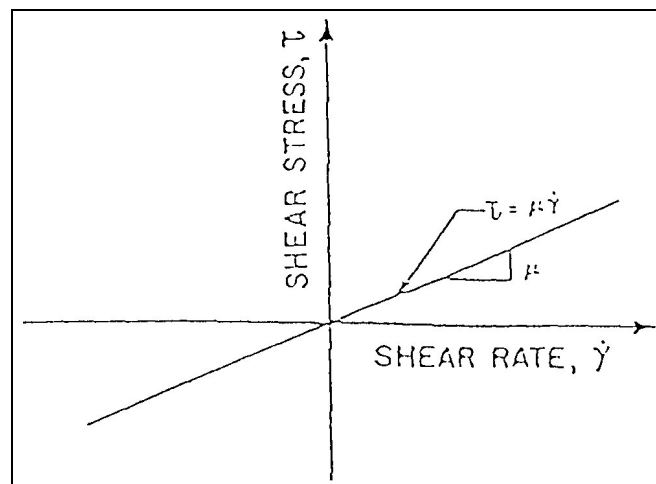

Figure 8.2 Shear stress vs. shear rate for a Newtonian fluid.

8.2. Effect of pressure and temperature on viscosity

Viscosity of fluids varies with pressure and temperature. For most fluids the viscosity is rather sensitive to changes in temperature, but relatively insensitive to pressure until rather high pressures have been attained. The viscosity of liquids usually rises with pressure at constant temperature.

Water is an exception to this rule; its viscosity decreases with increasing pressure at constant temperature. For most cases of practical interest, however, the effect of pressure on the viscosity of liquids can be ignored.

Temperature has different effects on viscosity of liquids and gases. A decrease in temperature causes the viscosity of a liquid to rise. Effect of molecular weight on the viscosity of liquids is as follows; the liquid viscosity increases with increasing molecular weight.

8.3. Methods for Measuring Viscosity

8.3.1. Capillary Type Viscometer

Viscosity of liquids is determined by instruments called viscosimeter or viscometer. One type of viscometer for liquids is the Ostwald viscometer (Figure 8.3). In this viscometer, the viscosity is deduced from the comparison of the times required for a given volume of the tested liquid and of a reference liquid to flow through a given capillary tube under specified initial head conditions.

During the measurement the temperature of the liquid should be kept constant by immersing the instrument in a temperature-controlled water bath.

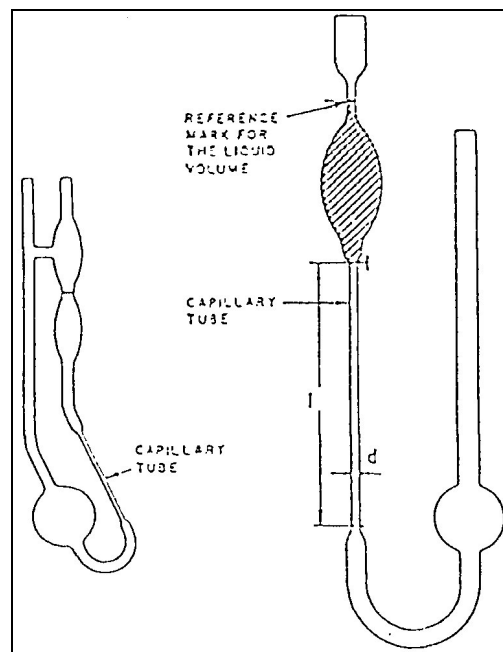

Figure 8.3 Two types of Ostwald viscometers.

In this method the Poiseuille's law for a capillary tube with a laminar flow regime is used

$$Q = \frac{V}{t} = \frac{\Delta P \pi r^4}{8 \mu l} \quad (8.2)$$

Where t is time required for a given volume of liquid V with density of ρ and viscosity μ to flow through the capillary tube of length l and radius r by means of the pressure gradient ΔP . The driving force ΔP at this instrument is ρgl . Then

$$\frac{V}{t} = \frac{\pi r^4 \rho gl}{8 \mu l} \quad (8.3)$$

Or

$$\mu = \frac{\pi r^4 \rho gl}{8V} = \text{Consant} \cdot \rho t \quad (8.4)$$

The capillary constant is determined from a liquid with known viscosity.

8.3.2. Falling Ball Viscometer

Another instrument commonly used for determining viscosity of a liquid is the falling (or rolling) ball viscometer (Figure 8.4), which is based on Stoke's law for a sphere falling in a fluid under the effect of gravity. A polished steel ball is dropped into a glass tube of a somewhat larger diameter containing the liquid, and the time required for the ball to fall at constant velocity through a specified distance between reference marks is recorded. The following equation is used

$$\mu = t(\rho_b - \rho_f)K \quad (8.5)$$

Where

μ = absolute viscosity, cp

t = falling time, s

ρ_b = density of the ball, g/cm³

ρ_f = density of fluid at measuring temperature, g/cm³

K = ball constant.

The ball constant K is not dimensionless, but involves the mechanical equivalent of heat.

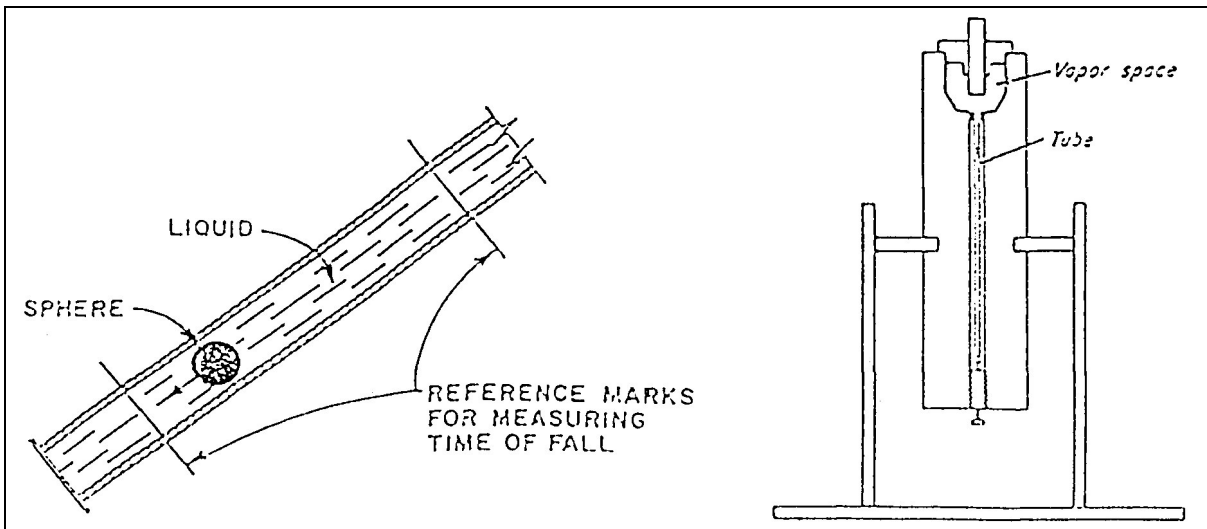

Figure 8.4 Schematic diagram of the falling ball viscometer.

The rolling ball viscometer will give good results as long as the fluid flow in the tube remains in the laminar range. In some instruments of this type both pressure and temperature may be controlled.

8.3.3. Rotational Viscometer

Other often used viscometers especially for non-Newtonian fluids are the rotational type consisting of two concentric cylinders, with the annulus containing the liquid whose viscosity is to be measured (Figure 8.5). Either the outer cylinder or the inner one is rotated at a constant speed, and the rotational deflection of the cylinder becomes a measure of the liquid's viscosity.

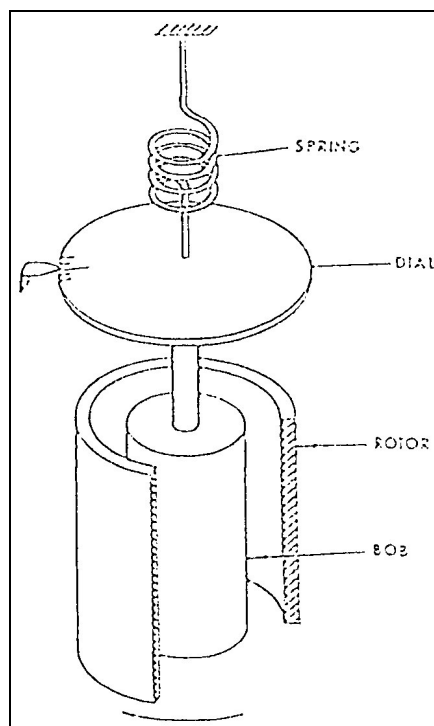

Figure 8.5 Schematic diagram of the rotational viscometer.

When the distance between the cylinders d , is small we can define the velocity gradient for laminar flow regime as

$$\frac{dv}{dr} = \frac{\omega R}{d} \quad (8.6)$$

Where R is radius of the inner cylinder (bob) and ω is angular velocity of the outer cylinder (rotor) defined by $\omega = 2\pi n$. When the rotor is rotating at a constant angular velocity ω and the bob is held motionless, the torque from the torsion spring on the bob must be equal but opposite in direction to the torque on the rotor from the motor. The effective area of the applied torque is $2\pi R h$ where h is length of the cylinder. The viscous drag on the bob is $k\theta R$, where k is the torsion constant of the spring and θ is angular displacement of the instrument in degrees. Then

$$F = \frac{k\theta R}{2\pi R h} = \mu \frac{dv}{dr} = \mu \frac{\omega R}{d} \quad (8.7)$$

Which gives

$$\mu = \frac{k\theta d}{2\pi h \omega R} = \frac{K\theta}{\omega h} \quad (8.8)$$

Where K is the instrument's constant which is determined by calibration.

9. VAPOR PRESSURE OF A PURE LIQUID

9.1. Definitions

When a pure liquid is placed in an evacuated bulb, molecules will leave the liquid phase and enter the gas phase until the pressure of the vapor in the bulb reaches a definite value, which is determined by the nature of the liquid and its temperature. The equilibrium vapor pressure is independent of the quantity of the liquid and vapor present as long as both phases exist in equilibrium with each other at the specified temperature. As the temperature is increased, the vapor pressure also increases to the critical point, at which the two-phase system becomes a homogeneous, one-phase fluid.

If the pressure above the liquid is maintained at a fixed value (say by admitting to the bulb containing the liquid), then the liquid may be heated up to a temperature at which the vapor pressure is equal to the external pressure. At this point vaporization will occur by the formation bubbles in the interior of the liquid as well as at the surface; this is the boiling point of the liquid at the specified external pressure is seen to be identical with the variation of the vapor pressure with temperature.

9.2. Theory

We are concerned here with the equilibrium between a pure liquid and its vapor:

$$X(l) = X(g) \quad (P, T) \quad (9.1)$$

It can be shown thermodynamically that a definite relationship exists between the values P and t at equilibrium as given by

$$\frac{dP}{dT} = \frac{\Delta S}{\Delta V} \quad (9.2)$$

In equation (9.2) dP and dT refer to infinitesimal changes in P and T for an equilibrium system composed of a pure substance with both phases always present: ΔS and ΔV refer to the change in S and V one phase transforms to the other at constant P and T . Since the changes in state (1) isothermal and ΔG is zero, ΔS may be replaced by $\Delta H / T$. The result is:

$$\frac{dP}{dT} = \frac{\Delta H}{T\Delta V} \quad (9.3)$$

Equation (9.2) and (9.3) is known as the Clapeyron equation. It is an exact expression, which may be applied to the phase equilibria of all kind although it has been presented here in terms of the one component liquid vapor case. Since the heat of vaporization ΔH_v is positive and ΔV is positive for vaporization, it is seen immediately that the vapor pressure must increase with increasing temperature. For the case of vapor-liquid equilibria the range of vapor pressures less than 1 atm, one may assume that the molar volume of the liquid V_L is negligible in comparison with that of the gas V_g , so that $\Delta V = V_g$. This comparison is very good in low-pressure region, since V_L is usually only a few tenths of a percent of V_g . Thus we obtain

$$\frac{dP}{dT} = \frac{dH}{TV_g} \quad (9.4)$$

Since $d(\ln P) = dP/P$ and $D(1/T) = -dT/T^2$ we can rewrite Eq.(9.4) in the form

$$\frac{d(\ln P)}{d(1/T)} = -\frac{dH_v}{R} \frac{RT}{PV_g} = -\frac{dH_v}{Rz} \quad (9.5)$$

Eq.(9.5) is a convenient form of the Clayperon equation. We can see that if the vapor were a perfect gas ($z=1$) and ΔH_v were independent of temperature, then a plot of $\ln P$ vs. $1/T$ would be a straight line the slope of which would determine ΔH_v . Indeed for many liquids $\ln P$ is almost a linear function of $1/T$, which implies at least that $\Delta H_v/z$ is almost constant.

Let us now consider the equation of gas imperfections, i.e., the behavior of z as a function of temperature for the saturated vapor. It is difficult to carry out PVT measurements on gases close to condensation and such data are scarce, but data are available for water, and theoretical extrapolations have been made for the vapor of "normal" liquids based on data obtained at higher temperature. In general it is clear that z decreases as the temperature increases. Water, due to its high critical temperature, is a reasonably ideal gas even at 100°C where z equals 0.986. But n-heptane at its 1 atm boiling point of 98°C has a value of z equal to 0.95 and is relatively non-ideal. For many substances, sizable gas imperfections are present at even pressures below 1 atm.

Next we must consider the variations of ΔH_v with temperature. For a change in state such as Eq.9.6:

$$\Delta H_{T_2} = \Delta H_{T_1} + \int_{T_1}^{T_2} \Delta C_p dT + \int_{P_1}^{P_2} \left(\frac{\delta \Delta H}{\delta P} \right)_T dP \quad (9.6)$$

Since the final term is zero for a perfect gas and small for most real gases, it is possible to approximate Eq. (9.6) by

$$\Delta H_{T_2} = \Delta H_{T_1} + \Delta c_p (T_2 - T_1) \quad (9.7)$$

Where the average value over the temperature interval, c_p , is used. For H_v to be independent of temperature, c_p must be very close to zero, which is generally not true. Heat capacities for water, benzene, and n-heptane are given below as typical examples.

For n-heptane, the specific heat of both gas and liquid changes rapidly with temperature; use of average values will only give an order of magnitude result. In general, the value of ΔH_v will decrease as the temperature increases.

Compound	Temperature range	Average values, cal.deg-1.mol-1		
	°C	cp (g)	cp (l)	dcp
Water	25 - 100	8	18	-10
Benzene	25 - 80	22	35	-3
n-Heptane	25 - 100	47	58	-11

Since both ΔH_v and z decrease with increasing temperature, it is possible to see why $\Delta H_v / z$ might be also constant and give a nearly linear plot of $\ln P$ versus $1/T$.

10. EXPERIMENTS

10.1. Effective Porosity Determination by Gas Expansion Method (Experiment 1)

10.1.1. Description

The helium porosimeter uses the principle of gas expansion, as described by Boyle's law. A known volume (reference cell volume) of nitrogen gas, at a predetermined pressure, is isothermally expanded into a sample chamber. After expansion, the resultant equilibrium pressure is measured. This pressure depends on the volume of the sample chamber minus the rock grain volume, and then the porosity can be calculated.

Note: Although this experiment is originally designed to be performed by helium, due to the unavailability of helium nitrogen will be used. It has been shown in a study by Gümrah [1994] that the difference in the porosity values obtained by helium and nitrogen are very close to each other.

10.1.2. Experimental set-up

The rock samples that are conventionally, but not essentially, cylindrical are placed in one of two matrix cups, depending on sample size. The matrix cups are 1 inch (25 mm) and 1.5 inch (38 mm) diameter, each capable of accommodating samples up to 3 inches (76 mm) long.

The matrix cups are seated in the porosimeter so that the cup base precisely located on top of a piston housed within a piston chamber. Compressed air, or nitrogen, set at a pressure of 110 psig, is allowed into the base of the piston when the 'piston' valve is in the 'UP' position. The gas pressure forces the core holder upwards against the top of the piston chamber, an 'O' ring seal on top of the holder isolating the volume in the holder.

The porosimeter is supplied with two reference volumes, as standard, each of which is selected by operation of valves V2 & V3, both these valves can be opened at the one time giving a third reference volume.

16 calibration blocks of known grain volume are supplied with the apparatus. The 4 filler plugs, which are also supplied with the instrument, are coded F to differentiate them from the calibration blocks. These are stainless steel billets that are used to calibrate and fill excess dead volume in each core lengths less than 3 inches are used. Failure to select the correct reference/filler plug combination, will, in certain circumstances, lead to inaccuracies in grain volume determination.

Each reference volume is connected to a gauge transducer (by selection of either V2 or/and V3) that has been calibrated over the range 0 to 100.0 psig.

The helium expansion cycle is controlled using two of the 'toggle' valves on the cup support. The left hand valve (V1) allows helium (in the ON position) into the reference chambers (selected using valves V2 and/or V3) or isolates the supply while the right hand valve (V4) allows the gas to be expanded into the cup (EXPAND), from the reference chamber(s), or vents the cup to atmosphere (VENT). The sample holder raise (UP)/lower (DOWN) action is controlled by valve marked accordingly on the front panel.

It is vital to ensure that grain volume determination is made under reasonably constant ambient laboratory conditions.

10.1.3. Operation of Instrument

1. After measuring the dry weight (and if required the bulk volume) of the core sample, place it in the appropriate sample holder and select the corresponding reference volume size using valves V2 and/or V3.
2. Locate the sample holder such that the base of the holder is free to rotate when positioned on top of the piston block. Ensure that 'O' ring seal is correctly positioned in groove on top of sample holder.
3. Toggle the piston valve to 'UP' position, located on the front panel. The compressed air admitted when the cylinder valve is actuated, forces the piston and sample holder to seal against the top of the piston block chamber. Prior to grain volume measurement, any air trapped in the core holder should be purged, by following stages 4 to 6.
4. Toggle valve V4 to 'VENT' position. The sample chamber and reference volume is now open to atmosphere.
5. Toggle V1 (Helium) valve to 'ON'. Helium gas will enter the selected reference volume. Set a pressure of between 95 psig and 100 psig, using the helium regulator. Then toggle V1 (Helium) valve to the 'OFF' position.
6. Toggle V4 valve to 'EXPAND'. Helium now expands into the core holder. Toggle V4' valve to 'VENT' to vent air/helium.
7. Toggle V1 (Helium) to 'ON'. Adjust helium regulator to provide a pressure in the selected reference volume of either 100.00 psig exactly, or, if preferred, a pressure of between 95 psig and 100 psig. When stable pressure has been obtained (or when the rate of pressure increase or decrease slows significantly), then
8. Toggle V1 (Helium) 'OFF'. Helium is now locked in the reference volume at a pressure that should be stable (< 0.01 psig change) within 2 to 3 seconds.
9. When pressure stable, note pressure value, P_r , then :
10. Toggle V4 valve to 'EXPAND'. Helium now expands, from the selected reference volume into the sealed sample holder. Pressure in the system usually stabilizes after 8 seconds to 45 seconds although longer periods may be required for 'TIGHTER' samples. Note stable expanded pressure, P_{xc} . If the expanded system does not achieve stability then a leak from the cup or the expand valve must be suspected.
11. Toggle V4 valve to 'VENT' position to relieve chamber pressure.
12. When the test is complete, toggle piston valve to 'DOWN' position and remove sample holder when the piston is fully retracted.

10.1.4. Calculations

Calculate effective porosity and grain density of the core sample applying the following procedure.

Boyle's Law states that for an ideal gas at a pressure P within a volume V , at constant temperature, then:

$$PV = \text{constant} \quad (10.1)$$

The product of the initial pressure and volume of the helium in the system is equal to the final pressure and volume of the helium in the system. Therefore, if a sample of unknown grain volume is placed in the coreholder, its grain volume can be calculated from:

$$P_r V_r = P_s (V_r - V_s) \quad (10.2)$$

and

$$P_r V_r = P_{xc} (V_r + V_s - V_g) \quad (10.3)$$

Where P_{xc} is the gauge pressure reading obtained when the helium expands into the specimen chamber and corrected for temperature where applicable. Calculation of the unknown grain volume, V_g , requires knowledge of P_r, V_r and V_s , (reference pressure, reference volume and sample chamber volume) for the particular reference volume/core size combination selected, together with a measurement of the expanded corrected pressure in the system, P_{xc} . For each reference volume/core size combination, V_r and V_s , the unknown specimen grain volume, V_g , can be calculated from:

$$V_g = \frac{P_{xc} (V_r + V_s) - P_r V_r}{P_{xc}} \quad (10.4)$$

The effective core porosity fraction ϕ can then be found from:

$$\phi = \frac{V_b - V_g}{V_b} \quad (10.5)$$

Where V_b is the bulk volume of the specimen, and $(V_b - V_g)$ is the sample pore volume (V_p).

Grain density; ρ can be found using:

$$\rho_g = \frac{W_d}{V_g} \quad (10.6)$$

Where W_d is the specimen dry weight.

PETE 216
EXPERIMENT – 1
DETERMINATION OF POROSITY BY GAS EXPANSION METHOD
DATA SHEET

Date:

Group no & members:

Assistant:

Grain Volume (cc)	Reference Pressure (psig)	Expanded Corrected Pressure (psig)

CALCULATED DATA:

Calibration curve is of the form:

$$\text{Grain Volume } (V_g) = K - C / P_{xc}$$

Where; P_{xc} = Expanded Corrected Pressure of Sample (psig),
 Constants, K=
 C=

CORE ANALYSIS:

Core radius, (inches) =
 Core height, (cm) =
 Average Referenced Pressure, P_{rave} =
 Reference Volume, V_r =
 Empty Holder Volume, V_s =
 Bulk Volume, V_b =
 Core Porosity =

10.2. Gas Permeability of Unconsolidated Sandpacks and the Effect of Gas Slippage (Experiment 2)

Permeability is a property of a porous medium and it is a measure of the ability of the rock to transmit fluids. During the measurement of the permeability some precautions must be taken. When liquid is used, it must not react with the rock, when gas is used corrections must be made for gas slippage. Gas slippage which is also known as “Klinkenberg effect” occurs when mean free paths of gas molecules approach to the diameter of pore openings. The mean free path of gas molecules is a function of molecule size and the kinetic energy of the gas. Klinkenberg was the first to observe this phenomenon and proved that this effect is a function of the gas with which the permeability is measured.

Because gas is a compressible fluid, different permeabilities will be obtained at different pressures. However when these measurements are extrapolated to infinite pressure (i.e. when gases become liquid) k_L , equivalent liquid permeability can be estimated.

The equation that models this phenomenon is given as:

$$k_L = k_g - m \cdot 1 / P_{\text{mean}}$$

Where k_g is the gas permeability measured at different ΔP 's, m is the slope of k_g versus $1/P_{\text{mean}}$ graph and k_L is the intercept of this plot.

The experiment will be conducted in a porous medium pack where crushed limestone is used. Air will be used to measure the gas permeability. The schematic diagram of the test set up is given.

10.2.1. Test Procedure

1. Open the main gas (air) valve on the pressure air bottle. Adjust the pressure on the pressure regulator on the air bottle at about 6-7 bars.
2. Open the valve on the main entrance of the unconsolidated sand pack.
3. Adjust the gas pressure by rotating the valve just near the main valve by paying attention to the minimum pressure that will be enough to rotate the wet test meter attached to the atmospheric end of the sand pack.
4. Stepwise increase the pressure by rotating the circular valve and record time for one complete rotation of the wet test meter scale. One complete rotation of the wet test meter is three liters.
5. Record the flow rates and pressure readings at each step.
6. Determine k_g at each ΔP using Darcy equation.
7. Make a plot of observed permeability versus reciprocal of the mean pressure. (Mean pressure is $(P_{\text{in}}+P_{\text{out}})/ 2$ where P_{in} is the pressure you read at the inlet end of the sandpack and P_{out} is the pressure at the outlet end which is atmospheric pressure.
8. Determine effective liquid permeability.
9. Determine “ b ”, which is a constant for the sandpack used.

ΔP (atm)	Δt (sec)	Q (cc/sec)	P_{average} (atm)	$1/P_{\text{average}}$ (1/atm)

10.3. Determination of Porosity and Pore Size Distribution by Mercury Injection (Experiment 3)

10.3.1. Description

The determination of effective porosity of a porous plug is the first part of the measurement. Capillary pressure data will be obtained using mercury injection apparatus. Mercury-air capillary data and pore size distribution function, $D(R_i)$, of the sample will be determined as the second part of the measurement.

10.3.2. Experimental Set-Up

Mercury porosimeter will be used in this experiment. Mercury porosimeter is a versatile, accurate apparatus for determining effective porosity of consolidated porous core plugs. Capillary pressure curves for rocks can also be determined by mercury injection, because the method is simple to conduct and rapid. The data can be used to determine the pore size distribution, to study the behavior of capillary pressure curves, and to infer characteristics of pore geometry.

The mercury porosimeter consists of a 100 cc volumetric mercury pump, to which a pycnometer is attached. The pump has a precision ground and hard-chrome plated plunger and a precision measuring screw. The chamber of the pycnometer admits cores to 1 ¼ inch in length and 1 ½ inch long in diameter. The porosimeter has also a pressure gage. A rapid acting breech-lock closure with O-ring seal is provided for the pycnometer. A needle valve in the pycnometer lid opens to the atmosphere. The movement of the pump metering plunger is indicated on two scales. The right and left hand scales provide, respectively, decreasing and increasing readings with the forward stroke of the plunger. Both scales are graduated to read the plunger displacement in cubic centimeters. The hand wheel dial is graduated in 0.01 cc subdivisions and permits estimation of plunger displacement to 0.001 cc. The right hand scale, which has decreasing graduations, is the volume scale. The left hand scale, which has increasing graduations, is to indicate the pore space volume.

10.3.3. Procedure

1. Advance the pump piston into the cylinder until the mercury level is visible in the bottom window. Record the value of the volume on the pump. Now continue the mercury injection until mercury reaches the level in the top window of the pycnometer. Record the value. The difference between the two numbers is the volume within the pycnometer. Repeat this several times to verify the volume in the cell.
2. Withdraw the piston until the sample chamber is empty.
3. Insert a core sample that has been extracted and dried.
4. Replace and lock the cap assembly and line up the mercury to the zero level in the lower window. Record the scale reading to 0.01 cc.
5. Advance the piston carefully until the mercury appears at the zero level in the upper window.
6. Record the scale reading to 0.01 cc. Calculate the bulk volume of the sample by subtracting this reading from the reading found in step d.
7. Apply the pressure to the sample through the assembly panel and to the top of the pycnometer. Step the pressures in increments as desired. The initial pressure values could be 5, 10, 15... 60 atm
8. After the pressure is applied, the mercury will invade the sample. Turn the pump handle until the mercury level is observed in the top window. Record the new value. The difference between the new value and the previous value is the amount of mercury that has invaded the core sample.

9. Repeat this procedure at each pressure step. Record the data and analyze the data for bulk volume and mercury volume intrusion.

10.3.4. Calculations

1. Effective Porosity Calculations

- a. Volume of empty pycnometer and volume of the pycnometer with sample are determined to calculate the bulk volume of the sample.
- b. Pressure vs. volume data are taken during the experiment.
- c. Effective porosity of the sample is determined.

$$\phi = \frac{V_p}{V_b}$$

- d. S_{mi} (injected mercury saturation) is calculated. (Also called pore %)
- e. Related graphs (P_c vs. ΔV and P_c vs. S_{mi}) are plotted.

2. Capillary Pressure and Pore Size Distribution Calculations

- a. After necessary conversions, and using

$$P_c = \frac{-2 \times \sigma \times \cos \theta}{R_i}$$

Calculate R_i where R_i is the pore entry radius, in cm.

(The σ and θ values are given as 1400, and 480 dyne/cm respectively)

Then calculate $D(R_i)$, the pore size distribution function, using the equation below.

$$D(R_i) = \frac{P_c}{R_i} \times \frac{\partial S_{mi}}{\partial P_c}$$

(The derivative is obtained from P_c vs. S_{mi} graph)

- b. Plot R_i vs. $D(R_i)$ and P_c vs. $D(R_i)$

PETE 216
EXPERIMENT – 3
DETERMINATION OF POROSITY AND PORE SIZE DISTRIBUTION BY
MERCURY INJECTION

	V (cc)
Empty Pycnometer	
Pycnometer with sample	

$V_{\text{pyc}}(\text{empty}) =$
 $V_{\text{pyc}}(\text{sample}) =$

$V_{\text{bulk}} =$
 $\emptyset_{\text{eff}} =$

P(atm)	V1 (cc)	V2 (cc)
5		
10		
15		
20		
25		
30		
35		
40		
45		
50		
55		
60		
65		

Date :
 Group No :
 Assistant :

10.4. Determination of the Liquid Permeability of Consolidated Cores (Experiment 4)

10.4.1. Description:

Absolute permeability of a consolidated core to a liquid will be determined using the “Resistivity Injection System” in the laboratory. The system is designed to measure the resistivity of rocks also and for this experiment only liquid permeability will be determined.

What is achieved in this experiment is simply to create conditions so that Darcy Equation can be used. So a liquid of known viscosity is forced to flow through the cross-section of a core-plug while measuring the flow rate and pressure drop across the core as a function of time.

10.4.2. Purpose:

Permeability is a property of the rock and indicates how fast liquid (or gas) can flow through the reservoir rock to the well bore. The permeability of a reservoir rock is an important parameter and one of the ways of determining this property is by running laboratory experiments on core plugs.

10.4.3. Experimental set-up:

The set-up consists of 5 main parts (Figure 10.1):

1. Gas Supply (Pressurized air cylinder):

The pressurized air cylinder is used to supply high-pressure air to the system, or to be more specific, to the liquid container, where the liquid (water) will be forced to flow through the core-plug.

The air cylinder is equipped with a pressure regulator located between the cylinder and the connecting tubing to the system. The regulator is used to deliver the air at desired pressure levels. Regulator also prevents any damage to main system and connections that may result by high pressure gas which can be accidentally forced into the system.

2. Liquid Container (Piston Cylinder):

The Liquid Container is a simple piston cell (a small, cylindrical tank equipped with a piston), which acts as the reservoir for the liquid (water) to flow through the core-plug. It is placed behind the main panel.

Liquid Container is separated into two compartments by a piston. Below the piston there is the water and above it is the air supplied. The high-pressure air coming from the tank pushes the piston down, thus pushing the water into the core holder.

3. Main Panel & Controls:

Main panel is a framework to keep all connections, valves, inlets and outlets, pressure gauge, core holder and liquid container in an order and at a fixed place.

On the front side of the panel there are inlets and outlets to the system, control valves, pressure gauge, Core Holder. On the rear side, there are the liquid container and connections.

The pressure gauge indicates inlet pressure of the liquid flowing through the core-plug.

4. Core Holder:

Core Holder is a vertically positioned; stainless steel cylinder which houses the core-plug. There is a viton* sleeve inside the Core Holder, between the core and stainless steel core holder. So, when the core-plug is installed in the center, there is this viton sleeve which is used to apply overburden pressure on the core plug. Between the viton sleeve and steel cylinder the Confining Liquid is pumped, causing the viton sleeve to cling to the core surface and prevents any by-passing of injected fluid. This ensures injected liquid (water) to pass through the core-plug's cross-section.

5. Confining Module:

The Confining Liquid mentioned in the core holder part is pumped in to the core holder using the confining module, which is the box shaped apparatus next to the main panel.

There, a pressure gauge showing the applied confining pressure, two valves for controlling the flow of confining liquid and a hand pump for pumping are located on this module.

10.4.4. Procedure:

Filling the Liquid Container (Piston Cell):

1. Ensure that no gas is supplied to the system and valve V3 is turned off.
2. Fill an ordinary syringe with tap water (water coming from the faucets in the lab.)
3. Connect the syringe to the liquid inlet on the main panel.
4. Turn the V2 valve to the FILL position.
5. Simply inject the water to the container using the injector.
6. Switch the V2 valve back to its previous position (FLOW) and remove the connected syringe.
7. Repeat this work several times until no more water could be pushed in the container, so that container is full.

Placing the core-plug:

1. Assure that no gas is supplied to the system and valve V3 is turned off while valve V4 is turned on in order to prevent any vacuum that could be created when removing the cap (removable top part) of core holder.
2. Check that no confining pressure exists in the core holder by observing the gauge on the confining module. If there is any pressure turn on the RETURN and FLOW valves.
3. Simply remove the top part.
4. Push the black "Ejector Handle" found at the bottom of holder all the way up until its platen upper-end can be seen from the upper side of core holder.
5. Place your core-plug on the upper-end of ejector handle and pull it back to its original position.
6. Place the top cap back on the holder and push the ejector handle (once more) upwards to fit the core inside.
7. Tighten the hand wheel at the bottom of core holder.
8. Applying Confining Pressure (overburden pressure) to the Core Holder:
9. In case there is some water found in the core holder turn the valve V4 on. So, when the confining pressure is applied water can flow out. If this not done, the system can be damaged.

* Viton is a trade mark; it is a rubber like material from which the core holder sleeve is manufactured.

10. Open the RETURN and FLOW valves on the confining module. Using the hand pump force confining liquid into the core holder a few times just to clean any gas remains between the viton sleeve and stainless steel core holder.
11. Then close the RETURN valve and continue pumping. When the desired confining pressure is reached, immediately close the FLOW valve too. Maximum confining pressure in this system can be 600 psia.
12. The core-plug is now confined and set-up is ready for the experiment.
13. After the experiment, before removing the core, the confining fluid must be removed from the holder by turning on the RETURN valve on the confining module which will release the core.

Conducting the Experiment:

1. Be certain that V1 valve is switched to the VENT position.
2. At the air cylinder, after assuring that the butterfly valve is closed (second valve), turn on the main valve and observe total pressure inside the cylinder from the main gauge of the pressure regulator on the air cylinder.
3. Then by adjusting the butterfly valve, obtain the pressure level that you like to supply to the system.
4. Get back to the main panel. Put a graduated cylinder to the liquid outlet and prepare your chronometer for recording.
5. Initially turn on the valves V3 and V4 (if it was ever closed before). There may be a little flow noticed which is not important at this time.
6. Slowly switch the V1 valve to the DRIVE position so that supplied pressure is directed into the water containing piston cell and a significant flow is obtained through the core.
7. Wait for some time for the core to be fully saturated and flow to be matured.
8. Replace the graduated cylinder at the outlet with a clean one and instantly start your chronometer and read your inlet pressure from the gauge on the panel.
9. Wait until the cylinder is filled with liquid to a readable level, remove the cylinder and stop the timer at the same time.
10. Move the V1 valve back to the VENT position in order not to waste laboriously filled water.
11. Read the collected amount of water and record all your data: volume, elapsed time and inlet pressure. As a usual practice the difference between injection pressure and confining pressure must be about 150-200 psi.
12. Repeat all the above process at least 5 times for different pressures recording time, pressure and flow rate.

10.4.5. Calculations:

Darcy Equation is used to calculate the absolute permeability of the core plug.

$$q = kA / \mu * \Delta P / L$$

$$q = (Q/t)$$

Where

Q is the volume of water collected in the liquid fill port during a certain time t,
 ΔP is the pressure differential across the core,

Find $\Delta P/L$, where L is the core length, and q/A , A= cross sectional area of the core, Plot $\Delta P/L$ versus q/A .

You should obtain a straight line for the Darcy Flow (laminar viscous flow) whose slope will be k/μ .

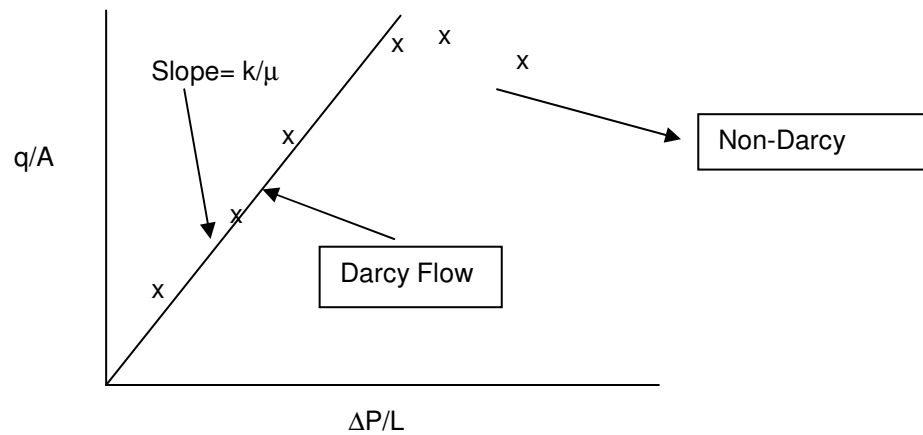

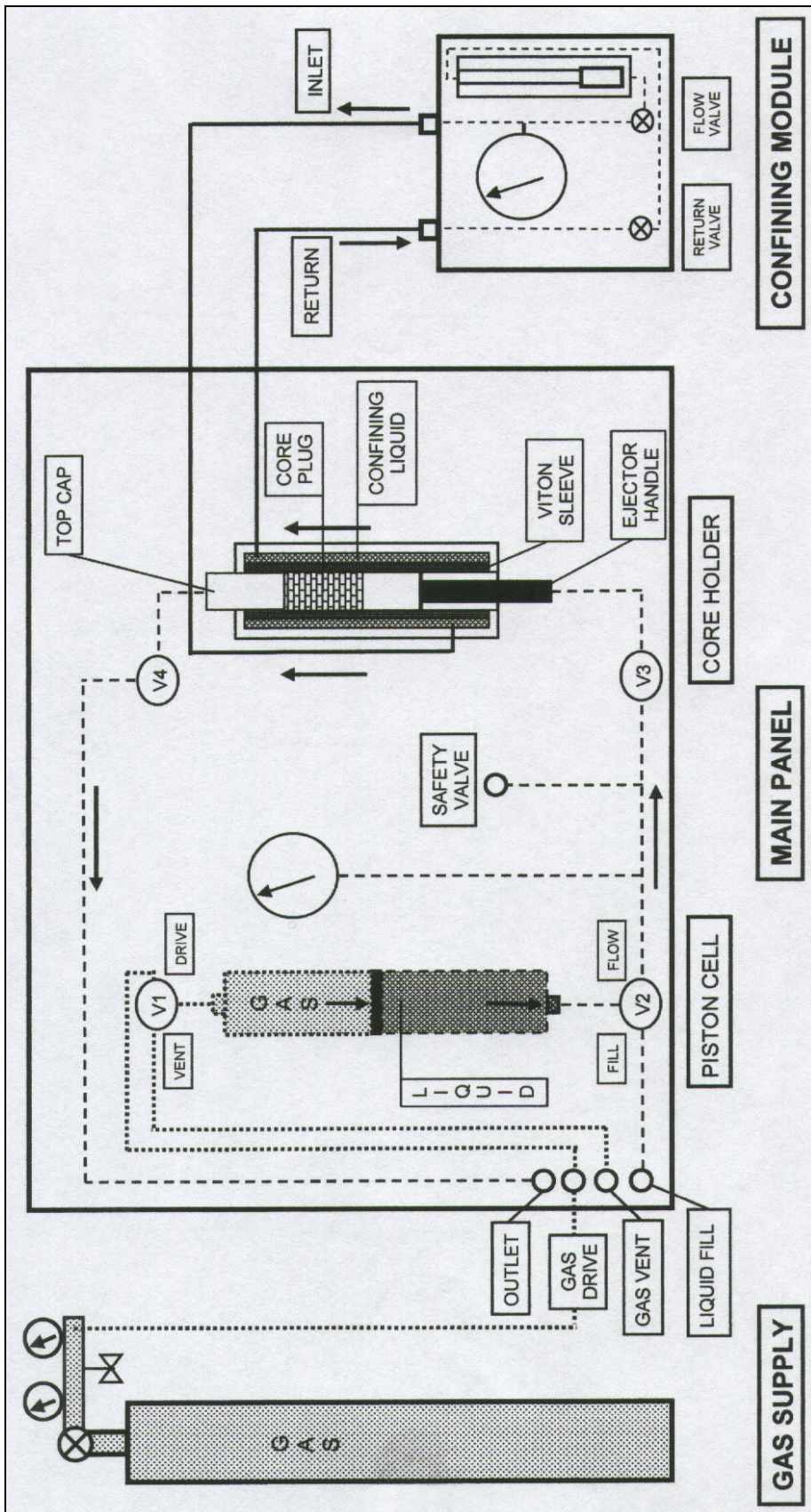

Figure 10.1 Resistivity Injection System

PETE 216
EXPERIMENT – 4
DETERMINATION OF LIQUID PERMEABILITY OF CONSOLIDATED CORES

Sample Name/No :
 Length, L :
 Diameter, d :
 Liquid Viscosity; μ :

ΔP (psi)	Duration, Δt (sec)	Volume of Liquid collected (ml)	Flow rate (cc/sec)

Calculation Sheet

q/A	$\Delta P/L$

Date :
 Group No :
 Assistant :

10.5. Measurement of Surface Tension & IFT with the Ring Tensiometer (Experiment 5)

10.5.1. Description:

The measurement of surface and interfacial tension as performed by a tensiometer is based on force measurements of the interaction of probe with the surface of the interface of two fluids.

10.5.2. Definition:

Surface and interfacial tension of fluids results from the molecular properties occurring at their surface or interface. Surface tension is the tendency of a liquid to expose a minimum free surface. It is skin effect at the surface or interface similar to the tension of a stretched membrane. Surface tension may be defined as the contractile tendency of a liquid surface exposed to gases. The interfacial tension is a similar tendency, which exists when two non-miscible liquids are in contact.

$$\sigma = \frac{\text{Surface Force, } F}{\text{Length Along Which Force Acts}}, \frac{\text{dynes}}{\text{cm}}$$

The DuNouy ring method utilizes the interaction of a platinum ring with the surface being tested. The ring is submerged below the interface and subsequently raised upwards. As the ring moves upwards it raises a meniscus of the liquid. Eventually this meniscus tears from the ring and returns to its original position. Prior to this event, the volume, and thus the force exerted, of the meniscus passes through a maximum value and begin to diminish prior to the actually tearing event. The calculation of surface and interfacial tension by this technique is based on the measurement of this maximum force.

10.5.3. Experimental set-up:

The DuNouy tensiometer consists of a platinum-iridium ring supported by a stirrup attached to the beam of a torsion balance. It measures the force needed to withdraw a platinum-iridium ring from the surface of a liquid. The ring is placed at the interface of two liquids or at the surface of a liquid with air. It is then pulled upward until it breaks free of the liquid and moves into the second liquid or into the air.

For interfacial tension measurement prepares a 1000 ml solution with water and 50 mg surfactant.

10.5.4. Procedure:

Surface Tension:

1. Place the water in the beaker,
2. Put the ring inside the beaker,
3. Make the scale (Dynes/cm for 6 cm ring) zero,
4. Begin to lower the platform that beaker is on,
5. Add tension to the ring to maintain the ring in position until the ring breaks free of the liquid.
6. Read scale at the point of breaking. Put the data on data sheet as surface tension.

Interfacial Tension:

1. Prepare solutions of different surfactant concentrations with water,
2. Put the first solution (with 0 mg/l surfactant concentration) in the beaker,
3. Put the ring inside the beaker,
4. Pour oil above the solution,
5. Make the scale zero,
6. Begin to lower the platform,
7. Add tension to the ring until the ring breaks the interfacial tension between the solution and oil.
8. Read scale at the point of breaking. Put the data on data sheet as interfacial tension of the selected surfactant concentration.

Repeat these procedures for the other solutions.

10.5.5. Conclusion:

Finally plot the graph of Interfacial tension vs. Solutions to see the effects of surfactant on the interfacial tension.

PETE 216
EXPERIMENT – 5
SURFACE & INTERFACIAL TENSION
DATA SHEET

Date:

Group no & members:

Assistant:

Surface Tension of Water = dynes/cm

Surfactant Concentration (mg/L)	Interfacial Tension (dynes/cm)

10.6. Fluid density using the Pycnometer Method and Hydrometer Method (Experiment 6)

10.6.1. Description

This experiment covers the determination of the density or relative density (specific gravity) of crude petroleum and petroleum products handled as liquids (e.g. stabilized crude oil, stabilized gasoline, naphthane, kerosene, gas oils, lubricating oils, and non-waxy fuel oils), using the very basic methods in which Pycnometer and Hydrometer are utilized.

10.6.2. Purpose

Density, as we all know, is a characteristic property of the matter which helps distinguishing it. In addition, by tracing the changes in density one might be able to determine the type and intensity of interactions a substance having with its surroundings (such as; mass flow, heat flow, pressure infliction).

Density measurements are frequently used in petroleum field and laboratories. For instance density of the drilling mud has to be measured frequently during the drilling. Also density of the produced crude while sustained in the surface tanks of the field is controlled using a hydrometer. When conducting experiments which involve the employment of any miscible liquids or any possibility of solid – liquid interaction, the density of the liquid(s) has to be determined often.

Having been mentioned the importance and usage of density in the petroleum field; this experiment has been devised to introduce the basic methods of accurately obtaining density of a liquid.

10.6.3. Experimental set-up:

There is rather a collection of tools for this experiment than a single apparatus to be considered as the set-up. This collection includes a highly sensitive electronic balance, a set of hydrometers with different scales, any number and size of pycnometers, thermometers and graduated cylinders as necessary.

Procedure for using Pycnometer

1. Thoroughly clean the pycnometer and stopper with a surfactant cleaning fluid (detergent or soap) rinse well with distilled water. Finally rinse with acetone and dry.
2. Weigh the clean, dry pycnometer with stopper and thermometer.
3. Fill the pycnometer with the liquid (oil, brine) at the same room temperature.
4. Put on the stopper and thermometer and be sure there is no gas bubble inside, and then dry the exterior surface of the pycnometer by wiping with a lint-free cloth or paper.
5. Weigh the filled pycnometer.

Procedure for using Hydrometer

1. Thoroughly clean the hydrometer.
2. Fill an adequate graduated cylinder with the liquid whose density is going to be measured.
3. Immerse the hydrometer in the filled cylinder and read the specific gravity.

Procedure for Experiment

1. Fill an adequate graduated cylinder with exactly 1 liter of distilled water.
2. Record your hydrometer reading for this water in the cylinder as well as the liquid temperature and atmospheric pressure.
3. Pour some of the water to a previously dried pycnometer, note your readings using pycnometer method, the liquid temperature and atmospheric pressure. Be careful not to spill and waste any of this water since it is going to be transferred back to the cylinder.
4. Transfer the water in the pycnometer back to the cylinder and ensure that you still have 1 liter of water in it.
5. Add proper amount of salt to the cylinder in order to obtain the required salt solution by weight percent. Then stir the solution until all the salt has been dissolved.
6. Repeat parts 2, 3, 4 for this solution.
7. Obtain higher weight percent salt solutions by adding just the differential amount of salt to the previously used solution.

When using a single liquid (like petroleum or products) instead of salt solutions of various proportions; you just need to follow the hydrometer and pycnometer procedures. Yet, this time you should repeat your readings 4 times for the pycnometer and 2 times for the hydrometer for the sake of precision and uncertainty analyses.

10.6.4. Calculations

1. Calculate liquid density separately for each measurement, for both of the methods.
2. Calculate average density for each measurement by finding the mean of the 2 values obtained by both methods for each solution.
3. Propose a theoretical density for each salt solution.
4. Calculate the average absolute uncertainty for average densities obtained in part 2 using the theoretical values.
5. Calculate the specific gravity for the values of part 2.
6. When a single liquid is used;
7. Calculate the liquid density separately for each measurement, for both of the methods.
8. Calculate 2 distinct average density values first by averaging the 4 pycnometer densities and then by averaging the 2 hydrometer densities.
9. Calculate the average absolute uncertainty using the above 2 average densities.
10. Calculate the specific gravity for the values of part 2.
11. Analyze the uncertainty sources of the pycnometer method.

Table 10.6.1: Density of water, kg/m³ at different temperatures

Temperature	Density
22.5	997.65
22	997.54
21	997.39
18	998.59
18.5	998.50
19	998.40
19.5	998.31
20	998.20
20.5	998.10
21	997.99
21.5	997.88
22	997.77

PETE 216
EXPERIMENT – 6
FLUID DENSITY USING THE PYCNOMETER AND HYDROMETER METHODS

NaCl Concentration weight %	Pycnometer		Hydrometer Reading Sp. Gr.	Liquid Temperature °C / °F	Atmospheric Pressure Atm / bar / psi
	Empty Weight grams	Full Weight grams			
0					
5					
10					
15					

Liquid: Reading	Pycnometer		Hydrometer Reading Sp. Gr.	Liquid Temperature °C / °F	Atmospheric Pressure Atm / bar / psi
	Empty Weight grams	Full Weight grams			
1					
2					
3					
4					

Liquid: Reading	Pycnometer		Hydrometer Reading Sp. Gr.	Liquid Temperature °C / °F	Atmospheric Pressure Atm / bar / psi
	Empty Weight grams	Full Weight grams			
1					
2					
3					
4					

Date :

Group No :

Assistant :

10.7. Liquid Viscosity Measurement Using Capillary Tube Viscometer, Cone and Plate Type Viscometer, Saybolt Viscometer (Experiment 7a, 7b, 7c)

10.7.1. Experiment 7a - Ostwald Type Viscometer

Capillary type viscometers are used for kinematic viscosity measurements. Ostwald type is an example for capillary viscometers. In capillary viscometers the time is measured in seconds for a fixed volume of liquid to flow under gravity through the capillary tube at a closely controlled temperature. The kinematic viscosity is the product of the measured flow time and the calibration constant of the flowmeter. The dynamic viscosity can then be obtained by multiplying the measured kinematic viscosity by the density of the liquid. Since viscosity is a function of temperature at atmospheric pressure for liquids it must be measured in a temperature controlled system. The capillary tube must be selected to fit to the viscosity of the sample to be measured.

10.7.2. Procedure

1. Turn the 4-heat switch to the “high” position. This is for a fast heat-up and should only be used to bring the bath up to the required temperature. (25⁰C)
2. Allow the apparatus to stabilize by observing temperature stabilization for five minutes. This step is made for four different temperature values.
3. To shut –off, merely turn off the line switch.
4. Place the viscometer into the constant temperature bath. Allow ten minutes for viscometer to reach equilibrium at 800 F (30⁰C).
5. Apply suction to the tube and bring the sample (Diesel) into top bulb.
6. Using a chronometer, measure the efflux time by allowing the sample to flow freely through mark “A”, to “B”. Record the time for the meniscus to pass from “A” to “B”.
7. Repeat the measurement by repeating steps 5-6; see if you obtain repeatable readings.
8. Repeat the experiment at 30, 35, and 40.

10.7.3. Calculations

1. Calculate the viscosity by multiplying the efflux time (seconds) with the viscometer constant and report the result as viscosity in CST unit. Density values of diesel for different temperatures are given in a table.
2. Plot viscosity vs. time, viscosity vs. temperature.
3. Find the 45, 50, 55, 60 ⁰C viscosity values by linear interpolation from the data measured.

Temperature(⁰ C)	Time(sec)	Kinematic Viscosity(cst)	Density(g/cc)
25			
30			
35			
40			
45			
50			
55			
60			

Kinematic Viscosity = 0.35 cst/sec * time

Absolute Viscosity = Kinematic viscosity* Density

10.7.4. Experiment 7b - Dynamic Viscosity by Cone and Plate Viscometer

The main objective of the measurement is to determine apparent or dynamic viscosity of a fluid. The cone and plate viscometer is used for this purpose. Cone and Plate viscometer is in fact nothing but a rotational type viscometer. If the aim of the researcher is to measure dynamic viscosity rotational viscometers are preferred. The unit of dynamic viscosity is centipoises. The relationship between kinematic (ν) and dynamic viscosity (μ) may be expressed as follows:

$$\nu = \frac{\mu}{\rho} \quad (10.7.1)$$

The unit of kinematic viscosity is centistokes.

Cone and plate viscometer is basically a rotational Mc Flurry type viscometer. There are two cylinders one inner and one outer. The fluid whose viscosity is to be measured is placed in between these two cylinders. The outer cylinder is rotated. The motion is transferred by Newton's third law action-reaction principle to the inner cylinder by the fluid. The inner cylinder is attached to a very sensitive spring. This spring is attached to the calibrated scale. This is the theory of cone and plate viscometer. The conversion changes due to the metal from which the spring is made.

Test Procedure

1. Set the Cone and Plate viscometer temperature control to 25°C.
2. Place a few droplets of the liquid on the lower plate (inner cylinder)
3. By pulling down the control arm, bring the outer (rotating) cylinder on top of the lower plate while pressing the rotation button.
4. Read the value on the display of the device.
5. Repeat steps 1-4 for a higher temperature value.

Sample Name				
Viscosity at 25 °C				
Viscosity at 100 °C				

Note: It is recommended to make an experiment initially in the absence of liquid. Thus the deviation on the display is recorded (error bound). This value should be subtracted from each data taken. It is necessary to wait ten minutes after changing the temperature of the device to get heated up before the test.

10.7.5. Experiment 7C - Viscosity Measurement by Saybolt Viscometer

Saybolt viscometer is also a capillary type viscometer. In this apparatus 60 ml of liquid is allowed to flow through a constriction of the sample bottle at 20°C and the efflux time is measured. The viscosity is reported in terms of seconds which is called Saybolt Seconds (SSU).

Temperature(°C)	Time(sec)	Kinematic Viscosity	Dynamic Viscosity

**PETE 216
EXPERIMENT 7
VISCOSITY MEASUREMENTS**

**EXPERIMENT 7A
CAPILLARY TYPE VISCOMETER**

Temperature (°C)	Time (sec)	Kinematic Viscosity (cst)	Density (g/cc)
25			
30			
35			
40			
45			
50			
55			
60			

Kinematic Viscosity = 0.35 cst/sec * time

Absolute Viscosity= Kinematic viscosity* Density

**EXPERIMENT 7B
CONE AND PLATE TYPE VISCOMETER**

Sample Name				
Viscosity at 25 °C				
Viscosity at 100 °C				

**EXPERIMENT 7C
SAYBOLT VISCOMETER**

Temperature (°C)	Time(sec)	Kinematic Viscosity	Dynamic Viscosity	Coefficient of Device

10.8. Vapor Pressure of a Pure Liquid (Experiment 8)

10.8.1. Description

In this experiment, the vapor pressure of a hydrocarbon will be determined. In order to calculate the vapor pressure of the hydrocarbon, "Reid Method" will be used. The change in vapor pressures as the temperature increases will be observed. By using these data, the molar heat of vaporization by using "Clasius- Clapeyron Equation" will be calculated.

10.8.2. Experimental Equipment and Procedure

Reid method covers the determination of absolute vapor pressure of a volatile crude oils, and natural gas liquids having nominal vapor pressure at 37,8 °C up to 7 bar (700 kPa). The method provides three variations of procedure to suit the types of material under test.

- For refined products with a Reid vapor pressure less than 1 bar.
- For refined products with a Reid vapor pressure between 1 bar and 1.8 bars and for semi-refined products with a Reid vapor pressure below 1.8 bars.
- For all materials with a Reid vapor pressure greater than 1.8 bars.

The Reid vapor pressure apparatus consists of two chambers, an upper chamber (air chamber) and a lower chamber (liquid chamber) with one opening. The ratio of their volume varies from 3.95 and 4.05. The liquid chamber that is used in this experiment has a volume of 135 cc and the air chamber has a volume of 545 cc. Thus the ratio is 4.03.

As for measuring the pressure manometer, a pressure gage may be used. In this experiment a calibrated pressure gage is used preferentially. The sample is taken into a container, which is to be filled with liquid. Then the container is placed in a 00C- 1.1 0C bath for full air saturation. The sample is then transferred to the liquid chamber very carefully. Before the transformation of liquid the container is taken out of the cool place and shaken rigorously. The liquid chamber is then coupled to the air chamber. The pressure gage is already connected to the top of the chamber. Then the whole assembly is immersed in water bath which is heated with an electrical heater and the water is stirred with air bubbles circulating from the bottom of the water bath. After 10 minutes or more when the pressure gage is stable, the specific reading is taken as the vapor pressure of that liquid at that specific temperature.

10.8.3. Calculations

Convert all the Celsius temperature readings to absolute temperature T and plot logP vs. 1/T. If there is a noticeable curvature draw a smooth curve through the points and also draw a straight line tangent to the curve at about the midpoint. If there is no systematic curvature, draw the best straight line through the points.

Determine the slope of the straight line or tangent. From equation

$$\frac{\partial(\ln P)}{\partial(1/T)} = - \frac{\partial H_v}{Rz}$$

Determine the slope, $-H_v / Rz$. Estimate the value of z at the appropriate temperature and pressure and calculate H_v in cal/mole. Report the value of heat of vaporization and the vapor pressure of liquid together with the applicable temperature (corresponding to mid-point of the range studied).

**PETE 216
EXPERIMENT – 8
VAPOR PRESSURE OF A PURE LIQUID**

HEXANE

UNKNOWN LIQUID

Pressure (psig)	Temperature(⁰ C)	Pressure (psig)	Temperature (⁰ C)

Date :

Group No :

Assistant :

11. LABORATORY REPORT FORMAT

- I. The report should be in English and the use of a word processor (WORD etc) is required.
- II. Main headings are to be centered and written in bold capital letters. Sub-titles should be written in small letters and underlined or bold.
- III. Drawing should conform to acceptable engineering standards.
- IV. Each report should contain the following sections.

1. **Title Page:** Should contain experiment name and number, group number, group members, and date.
2. **Table of Contents:** Should have the corresponding page numbers.
3. **Abstract:** Use an abstract of about 50 words to summarize the experiment, stating information and conclusions.
4. **Theory:** Explain theory, define terms, and outline any problems peculiar to this subject
5. **Procedure and Experimental Set-up:** Tell how the experiment was used and how tests were conducted. Describe experimental procedures and give experimental equipment used in the experiment with illustrations if possible.
6. **Calculations and results:** Presents results in clearer form. Give a sample calculation and tabulate your results, also include your data sheet and graphs. Interpret clearly the data you are presenting.
7. **Discussion:** Compare your results with theoretical values, explain in detail.
8. **Conclusions:** State directly and briefly your conclusions and the utility of these conclusions. Conclusions should not be confused with results and observations, which are facts. Conclusions are the lessons learned from interpretations of the facts. Give possible practical use of your observations.
9. **References:** References in the main text should be cited numerically in the order of their use in the text. The following format should be applied while citing different sources.

a) Reference to article

Raghavan,R., Cady, G.V., and Romey, H.J.Jr. "Well Test Analysis for the Vertically Fractured Wells 1", J.Pet.Tech, Aug.1972, 1014-1020

b) Reference to a book

Craft,B.C .and Hawkins,M.F: Applied Petroleum Reservoir Engineering, Prentice-hall Inc., New York,1959.

c) Reference to a paper presented at a meeting but not published

Spanos, P.D.AND Payne, M.L.: "Advances in Dynamic Bottom hole Assembly Modelling and Dynamic Response Determination", paper SPE 23905 presented at the 1992 IADC/SPE Drilling Conference, New Orleans, Louisiana, Feb.18-21

d) Reference to a company document, manual etc.

Ruska High Pressure Viscometer Operating Manual, Ruska Instrument Corporation, Houston, Texas, 1970.

e) Reference to a web page / Internet site:

Understanding a Hydrometer (*page or article title*)

http://www.brewsupplies.com/understanding_a_hydrometer.htm (*address*)

Accessed on 20.02.2002 (*date when the page was accessed*)